























AB

DOHABRANDS.

LET'S MAKE IT REAL

**STOCK  
CATALOGUE  
2022**

# INDEX

|   |                             |            |  |
|---|-----------------------------|------------|--|
|    | <b>BRANVE</b>               | <b>6</b>   |  <b>BRANVE®</b> |
|    | <b>EKSTON</b>               | <b>24</b>  |  <b>ekston®</b> |
|    | <b>OFFICE</b>               | <b>39</b>  |                 |
|    | <b>TECHNOLOGY</b>           | <b>75</b>  |                 |
|    | <b>WRITE</b>                | <b>123</b> |                 |
|    | <b>BAGS</b>                 | <b>183</b> |                 |
|    | <b>LEISURE &amp; TRAVEL</b> | <b>227</b> |                 |
|    | <b>DRINKWARE</b>            | <b>277</b> |                 |
|  | <b>HOME</b>                 | <b>313</b> |               |
|  | <b>SHOPPING</b>             | <b>339</b> |               |
|  | <b>KEYCHAINS</b>            | <b>363</b> |               |
|  | <b>PERSONAL</b>             | <b>387</b> |               |
|  | <b>KIDS</b>                 | <b>411</b> |               |
|  | <b>SUMMER</b>               | <b>429</b> |               |
|  | <b>TEXTILE &amp; RAIN</b>   | <b>441</b> |               |
|  | <b>CONNECT'IN</b>           | <b>492</b> |               |

**ORIGINAL  
LANYARDS®**

**PAPER'IN**

**BUTTON P'IN**

connecting  
**USB**you

connecting  
**LANYARD**you

**3D PRINT'IN**

**GRAPHIC'IN**

**DOM'ING**

connecting  
**BOTTLE**you

# QUALITY PRINTING SERVICES



## STICKERS [ STI ]

- Printing vinyl stickers with photographic quality and a wide variety of sizes and shapes.



## HYDROGLAZE [ HDG ]

- Hydroglaze is a technique that consists of spraying any pantone color, with a matt or glossy finish, onto glass, ceramic or porcelain.



## EMBROIDERY [ EDB ]

- The embroidery allows you to customise various types of fabric with great quality and perfection, many colors and distinctive designs.



## DIGITAL PRINTING [ DGL ]

- Digital printing involves printing paper, with photographic quality. This technique is widely used for labels or pins.



## HOT STAMPING [ HTS ]

- The stamp consists of reproducing designs through a hot press on leather products or imitation leather, ensuring an elegant and quality result.



## DIRECT TO GARMENT [ DTG ]

- Textile direct printing is a full colour digital printing technique for textiles, ideal for small quantities.



## DOMING [ DOM ]

- Doming consists of applying a layer of resin (epoxy) on printed paper, thus creating a 3D effect with a bright, resistant and long-lasting appearance.



## LASER [ LSR ]

- Laser engraving involves the use of a modulated laser beam, providing a precise, durable and elegant finish.



## FIRING [ FIR ]

- Firing is a technique that uses special paints heated to high temperatures, thus allowing complex logos and with great detail. It is ideal for glass, ceramic or porcelain.



## SANDBLASTING [ SND ]

- Sandblasting, creates a 3D effect with great detail. This technique is ideal for glass, ceramic or porcelain.



### SCREEN PRINTING [ SCR ]

• Silk-screening printing is a process of printing on a smooth surface that allows great image definition, even in various colors, with reliable and lasting results.

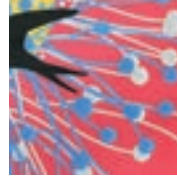

### TRANSFER [ TRS ]

• Transfer is a technique that allows you to transfer a multicolor image from paper to fabric producing very uniform results.



### ROTARY SCREEN PRINTING [ SRC ]

• Circular silk-screen printing is identical to the silk-screen printing process optimized for 360° printing.



### DIGITAL TRANSFER [ DTT ]

• Optimised transfer process for digital printing of small quantities, without color limits.



### TEXTILE PRINTING [ TXP ]

• Textile silk-screen printing is identical to the optimum silk-screen printing process for textile printing.

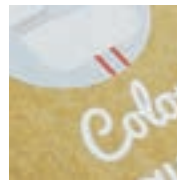

### DIGITAL UV [ DUV ]

• UV printing, which dries quickly thanks to the emission of ultraviolet light, is very appealing because it allows printing in various colors, quickly and with high quality.



### SUBLIMATION [ SUB ]

• Sublimation allows you to print images on concave surfaces, producing very defined results. This technique is resistant to extreme temperatures whether hot and cold.



### CIRCULAR UV (360) [ UVC ]

• Circular UV is identical to the UV process, but optimized for 360° printing.



### PAD PRINTING [ PDP ]

• Pad printing consists of transferring the ink into the product through a silicone cap. This technique is ideal for small objects and adapts to curved shapes.

🎧 ON REQUEST

✂️ NO CUSTOMISATION





The magnetism of strong personalities and the ability to match with you. BRANVE® is contemporariness and innovation, with a cosmopolitan design and pronounced character. Comfort, durability and elegance allied with practicality - For those who seek the luxury of functionality in every detail.

**THE BRAND THAT MATCHES**

[branve.com](http://branve.com)

# EMPIRE

Maintaining an identity in a world that demands organization and focus. Determined to differentiate the executive daily life, Empire presents itself as sophisticated, modern yet attentive to detail. In this empire, functionality and personality are pronounced in the materials that are carefully chosen, where each element has an inherent purpose - the form adapts itself to the function. Who said organization couldn't be elegant?





**A5 EMPIRE NOTEBOOK**

**93598**

The EMPIRE is an A5 notepad with a modern and minimalist design and with a business touch. The hard cover with split leather with PU that protects the interior, which intelligently splits into three distinct parts with a separator that allows you to identify each part. Its 240 pages are proportionally divided into plain, lined and dotted pages. Its minimalist design is complemented by the metallic detail on the closure, which is characteristic of this product line and enhances its elegance. The product is supplied with a pen holder (pen not included) and in a gift box.

📏 150 x 210 mm | Box: 197 x 250 x 28 mm

🔪 HTS - 35 x 10 mm

**EMPIRE BACKPACK**

**92680**

The EMPIRE backpack is city and sophisticated in split leather with PU. The main compartment is made of 2 padded dividers, compatible with a laptop up to 14" and a tablet up to 10.5", and several pockets for easy storage. The front has a large pocket. The side zippers have sturdy magnets and metal plates ideal for customisation. The back with padded backrest and fully padded straps ensure maximum comfort and the reinforced bottom corners ensure durability. Interior pockets. Metallic closure. The EMPIRE backpack has a trolley carrying strap, which makes it a versatile and practical object for both everyday and business trips. Supplied in a non-woven bag.

📏 290 x 370 x 90 mm | Bag: 530 x 500 x 80 mm

🔪 LSR - 15 x 15 mm





## EMPIRE SUITCASE II

92359

The EMPIRE II is a classic and sophisticated suitcase with two pockets designed to protect your laptop up to 15.6" and your tablet up to 10.5". Its design, like all products in this line, has been thought to the last detail and every detail makes EMPIRE II the ideal folder for an everyday object that goes unnoticed. The EMPIRE II finishing is made of high quality textured imitation leather. The versatility of different transport methods is equally noticeable in its trolley strap. EMPIRE II suitcase is supplied in a non-woven bag.

✂ 380 x 280 x 80 mm | Bag: 530 x 500 x 80 mm  
✂ LSR - 15 x 15 mm



## EMPIRE SUITCASE I

**92360**

The EMPIRE I is a modern executive suitcase with a sophisticated touch, in high quality textured imitation leather. It has a main compartment with 2 padded pockets, allowing you to store your laptop up to 14" and your tablet up to 10.5". The different ways of carrying this suitcase make it a versatile object, something that is reinforced by its trolley strap. The innovative EMPIRE I magnet closure on the side elevates the suitcase to a single object. All details are focused on its functionality as well as its aesthetics and an example of this are the metallic details used in the handle, which in addition to ensuring the quality of the EMPIRE I, ensure its uniqueness. EMPIRE I suitcase is supplied in a non-woven bag.

📏 370 x 270 x 80 mm | Bag: 530 x 500 x 80 mm  
 🛖 LSR - 15 x 15 mm





# DYNAMIC

Business and leisure can go hand in hand. It is important to maintain the hectic cosmopolitan rhythm and the secret is multi-functionality. Being versatile is knowing how to combine the improbable - the robustness and harmony, the practicality and nobility of materials. In the Dynamic, the objects are multiplied but are, simultaneously, unified: it's energy in movement.



## **DYNAMIC NOTEBOOK**

 **93597**

 The DYNAMIC is an A5 notebook thought and designed to be a functional and practical object with a touch of city elegance. It has two different writing notepads on each side that can be used and closed separately. It has a magnet closing system on the strap that goes around the notepad. The band has a different colour on each side, allowing its identification, giving a certain irreverence to the product. The exterior material is high quality imitation leather and 168D, textured and smooth. It has 256 pages that are divided proportionally between plain and lined pages, identifiable by the outer banner. The DYNAMIC notepad is unique in its design but also in its functionality, where duality makes it a perfect object for every moment of everyday life.

 150 x 210 mm | Box: 197 x 250 x 28 mm

 HTS - 35 x 10 mm

## **DYNAMIC 2 IN 1 BACKPACK**

**92682**

The DYNAMIC 2 in 1 is an urban backpack that stands out for its versatility and duality. Its efficient design allows it to be a unique and versatile object that discretely multiplies into a backpack and a travel bag. The backpack has two inside pockets, that allow the protection of your laptop up to 15.6" and your tablet up to 10.5". The large travel bag lets you perfectly organize your clothes for a 2 or 3 day trip. It has an anti-theft back pocket. Material 1680D imitation leather and elastic closures with PU plate. The DYNAMIC 2 in 1 also has a trolley socket that underlines its practical and functional side. The two parts of this backpack can be used separately or as a single piece. Supplied in a non-woven bag.

 300 x 420 x 200 mm | Backpack: 300 x 420 x 75mm |  
Travel bag: 300 x 420 x 130 mm | Bag: 550 x 580 x 210mm

 LSR - 40 x 10 mm



## U R B A N

The urban routine requires flexibility. While assuming an alternative and bold style, the Urban line is prepared for all the daily incidents, facing them with enthusiasm, lightness and the right dose of sobriety. Trendy items for those who are always ready for change.



## URBAN BACKPACK

**92683**

The URBAN is a versatile, high-density soft shell city tarpaulin backpack. Designed to hold a laptop up to 14" and 10.5" tablet. The URBAN's waterproofness makes it a unique object. The impermeability comes both in its fabric and in the design of the zippers that protect the inside of the backpack. The front pocket is spacious and the access to it is very intuitive. The adjustable straps and hand grip contribute to the versatility of the backpack. URBAN is supplied in a non-woven bag.

📏 400 x 300 x 70 mm | Bag: 530 x 500 x 80 mm

🔪 TRS - 140 x 160 mm



# MOTION

The challenges of urban life are overcome with boldness. Irreverence and comfort mark the Motion lines. With avant garde traces, these products belong to who dares - they have a strong personality and they stand out anywhere.



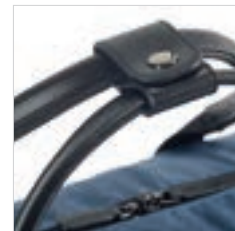

## MOTION BACKPACK

**92681**

The MOTION is a unique 600D backpack with irreverent design. Split leather with PU. The backpack has several compartments, inside pockets and two padded pockets purposely designed to protect a 15.6" laptop and 10.5" tablet. The padded straps and back accentuate the comfort of this backpack. The trolley strap is yet another feature that emphasizes the practical side of this backpack making it easy to carry around. The flap front pocket and side pockets are equally unique in their design, from the asymmetry of the front pocket to the hidden side pocket that can hold a water bottle. The MOTION is supplied in a non-woven bag.

± 410 x 330 x 150 mm | Bag: 530 x 500 x 80 mm  
 / LSR - 40 x 10 mm

## MOTION BAG

**92521**

The MOTION is a practical and stylish 600D cationic polyester travel bag with split leather with PU. Its spacious main compartment is ideal for storing clothes and other utilities needed for short trips. It also has four inside pockets and a front pocket with an asymmetrical design flap, which characterizes this line and gives it a modern look. It has a magnet closure. The practicality of this bag is matched by a detailed and careful design that leads to details such as the space to put the name tag, the metallic feet that protect the bag when set down, the design of the zipper that allows it to be closed with a lock (not included) and the straps designed to be adjustable and comfortable. MOTION is supplied in a non-woven bag.

± 500 x 300 x 250 mm | Bag: 700 x 450 x 75 mm  
 / LSR - 40 x 10 mm



# QUOTE

That which is most important should be registered. Tasks, messages, ideas - commitments and inspirations deserve the comfort of blank pages. Creativity gains space in the silent discovery of free pages. Be inspired by the geometry of forms or by the revisited and reinvented culture of places and traditions.





## GEOMETRIC NOTEBOOK



**93596**



The GEOMETRIC is an A5 hard cover imitation leather notepad. The design of the cover was inspired by geometric figures based on optical illusion patterns. The elastic band, which allows to close the notepad, the bookmark and the pen holder (pen not included) reinforce the usefulness of this notepad. More than a notepad, it is a support for communicating emotions. Something very personal and unique.

📏 140 x 210 mm | Box: 177 x 250 x 24 mm  
 📏 HTS - 40 x 30 mm



## TILES NOTEBOOK



**93737**



The TILES is an A5 hard cover imitation leather notepad with 256 lined pages inside. This whole notepad was designed based on cultural elements, in this case the Portuguese tiles. The elastic band that closes the notepad, bookmark and pen holder (pen not included) reinforces the usefulness of this notebook. More than a notepad, it is a support for communicating emotions. Something very personal and unique.

📏 140 x 210 mm | Box: 177 x 250 x 24 mm  
 📏 HTS - 40 x 30 mm

# INK

Transposing onto paper thoughts and ideas - the cult of handwriting. Writing instruments that combine different textures in a modern and elegant design. The flow of the ink as the rhythm of inspiration. Ink as the mentor of loose and correct words.

## **SIGN I**

 **81206**

 The SIGN I is a sleek metal ball pen with matte black finishing and stainless steel clip. The SIGN I is a sophisticated, minimalist design object that has blue Dokumental Ink® refill. It is supplied in a gift box.

∅10 x 135 mm | Box: 53 x 187 x 28 mm

LSR - 40 x 5 mm



## **SIGN II**

 **81207**

 The SIGN II is a sleek metal roller with matte black finishing and stainless steel clip. The SIGN II has black Dokumental Ink® refill. It is supplied in a gift box.

∅10 x 135 mm | Box: 53 x 173 x 28 mm

LSR - 40 x 5 mm



## **AUTOGRAPH**

 **81205**

 The AUTOGRAPH is a sophisticated ball pen and roller set. The Roller is matt black metal and stainless steel lid and the Ball pen is matt black metal and stainless steel clip. In this minimalist and exquisite set the ball pen and roller have blue Dokumental Ink® refill. It is supplied in a gift box.

∅10 x 135 mm | Box: 73 x 173 x 28 mm

LSR - 40 x 5 mm



## **STAIN**

 **81208**

 The STAIN is a textured roller and stainless steel lid. The STAIN roller is inspired by geometric lines, has a black Dokumental Ink® refill. It is supplied in a gift box.

∅10 x 135 mm | Box: 53 x 187 x 28 mm

LSR - 40 x 4 mm



**SIGN I**  
**81206**

**SIGN II**  
**81207**



AUTOGRAPH  
81205



STAIN  
81208



AUTOGRAPH  
81205





## NEO

**81001**

NEO is an avant-garde, ergonomic aluminum ball pen with twist mechanism that is designed for professionals who use a notepad and a tablet as their office. The silicone touch tip enhances its usefulness and the matt/glossy lacquered body adds elegance. The ball pen has a cross-type metal refill and black Dokumental® ink. This product comes in a cushioned gift box.

∅ 10 x 138 mm | Case: 175 x 41 x 20 mm  
PDP - 6 x 45 mm



## HOOK MATTE

**81003**

The HOOK Matte ball pen is elegant and sophisticated, that hardly goes unnoticed. It is a bronze ball pen with twist mechanism, bright chrome plating and iron spring clip, which gives it strength and flexibility. The shiny chrome-plated tip and double-finished body [platinum-plated interior and matt lacquered exterior] enhance not only the elegant design but the quality of the HOOK Matte. It has a G2 metal refill with blue Dokumental® ink. The Hook Matte is supplied in a gift box.

∅ 11 x 142 mm | Case: 175 x 41 x 20 mm  
PDP - 7 x 40 mm



HOOK MATTE  
81003



NEO  
81001



HOOK MATTE  
81003







Prolong moments and unique experiences by means of technology. The superior quality and contemporary aesthetics of ekston® turn into products with an exceptional performance that accompany us everywhere - an extension of experiences that exults emotions and challenges the limits of technology.

**Good things are all in here**

**[ekston.com](https://ekston.com)**





# SOUND

Involve yourself in the pure expression of sound. Give in to the deep and vibrating sound experience of the Ekston® products. Thrill yourself, without interruptions, without noise, only with emotions.



**GROOVY  
97928**

The GROOVY are comfortable and elegant headphones in imitation leather, metal and ABS, that are foldable and wireless. The GROOVY are a practical and an everyday product, that are supplied in a gift box.

200 x 160 x 73 mm | Box: 265 x 250 x 65 mm

PDP - 20 x 5 mm

- Foldable
- Microphone
- Volume control
- Call button
- Connection to mobile device's playlist
- Includes a cable



- Microphone
- Call button
- Connection to mobile device's playlist
- Loading box

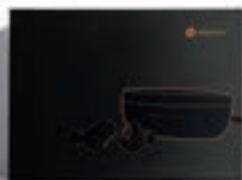

## DESCRY 97922

The DESCRY are metal and ABS headphones that are bold and distinctive. Their technical characteristics elevate it to a highly functional object. The DESCRY are supplied in a gift box.

▮ 31 x 78 x 38 mm | Charging box: 79 x 40 x 32 mm | Box: 128 x 110 x 58 mm  
 ↗ PDP - 25 x 10 mm



- Microphone
- Call button
- Connection to mobile device's playlist
- Loading box
- Water Resistant
- Includes a cable



## WIRETAP 97926

The WIRETAP are metal and ABS wireless headphones, with a bold and distinctive design. By allowing sound isolation and being waterproof these wireless headsets are distinguished by their quality and functionality. The WIRETAP are supplied in a gift box.

▮ 45 x 76 x 29 mm | Box: 126 x 124 x 49 mm  
 ↗ PDP - 25 x 10 mm



- Microphone
- Call button
- Volume control
- Connection to mobile device's playlist



- Microphone
- Call button
- Connection to mobile device's playlist
- Includes a cable



## HEARKEEN 97919

The HEARKEEN are versatile headphones in ABS and silicone , perfect for different everyday moments. Due to their versatile design, they can be used in more professional environments, or for sports.

▮ 165 x 153 x 10 mm | Box: 201 x 220 x 40 mm  
 ✂ PDP - 20 x 5 mm



## VIBRATION 97923

The VIBRATION are metal and ABS modern designed headphones that stand out for their metallic finished in the different details of the product. The VIBRATION are supplied in a gift box.

▮ 25 x 19 mm | Box: 88 x 97 x 45 mm  
 ✂ LSR - 14 x 3 mm



- Microphone
- Call button
- Connection to mobile device's playlist
- Includes a cable



## BLARE 97257

The BLARE is a modern and discreet ABS design speaker. The speaker is an object that becomes a partner at all times due to its technical and functional characteristics. The BLARE is supplied in a gift box.

▮ 60 x 63 x 70 mm | Box: 120 x 139 x 83 mm

✂ PDP - 20 x 40 mm



- Microphone
- Volume control
- Call button
- Connection to mobile device's playlist



## THUNDER 97258

The THUNDER is a textured fabric ABS speaker elegant and with detailed finishings. The speaker is an object that fits perfectly into a stylish and sophisticated environment and is supplied in a gift box.

▮ 73 x 196 x 54 mm | Box: 275 x 123 x 74 mm

✂ SCR - 40 x 15 mm





# WIRELESS CHARGERS + PORTABLE BATTERIES



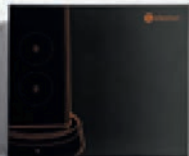

**THINK  
97916**

The THINK is a versatile portable battery with an ABS and PC charging base that allows it to be simultaneously used as a wireless charger. The THINK is an object of bold design and given its technical characteristics can be used either for travel (as a portable battery) or as wireless charger. The battery is supplied in a gift box.

145 x 90 x 97 mm | Box: 212 x 195 x 58 mm



- Lithium polymer battery
- Charges 2 devices simultaneously
- Universal compatibility
- LED indicator





- Universal compatibility
- Lithium polymer battery
- LED indicator
- Charges 2 devices simultaneously



**TRENCHER**  
**97925**

The TRENCHER is a portable fabric-lined battery pack in a rubber-finished ABS housing that is distinguished by its modern yet elegant and intimate design. TRENCHER is supplied in a gift box.

▮ 140 x 70 x 16 mm | Box: 212 x 112 x 29 mm  
 ▮ SCR - 45 x 15 mm



- Charges 2 devices simultaneously
- LED indicator
- Universal compatibility
- Lithium polymer battery



**CROWD**  
**97917**

The CROWD is an ABS portable battery with a sleek and innovative design, designed to be an intuitive, everyday object. The portable battery is supplied in a gift box.

▮ 98 x 64 x 14 mm | Box: 148 x 144 x 34 mm  
 ▮ SCR - 40 x 10 mm



- Compatible with smartphones with wireless charging technology



**HORDE**  
**97921**

The HORDE is a wireless charger that combines metal and fabric into a perfect crossover that culminates in a sleek and sophisticated designed object. The HORDE is compatible with smartphones that have wireless charging technology, making it an everyday ally.

⊥ 16 x 87 x 101 mm | Box: 169 x 154 x 34 mm  
🔗



- Compatible with smartphones with wireless charging technology



**MAGNET**  
**97920**

The MAGNET is a rugged wireless charger with a modern design in metal and acrylic. This charger has 10W charging power.

⊥ 14 x 107 x 100 mm | Box: 157 x 179 x 34 mm  
🔗 LSR - 20 x 5 mm





# SMART WATCHES

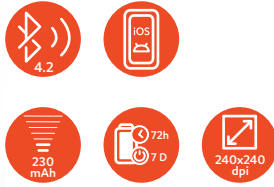

- Water Resistant
- Heart rate meter
- Sleep monitoring
- Connection to mobile device's playlist
- Alarm clock
- Mobile Phone Notifications

## THIKER I 57431

The THIKER I is a sophisticated water resistant smart watch with stainless steel strap. The THIKER I is a watch with features that allow it to be an ally for everyday life and is supplied in a gift box.

26 x 47 x 8 mm | Box: 120 x 120 x 70 mm

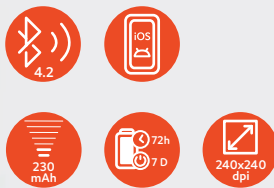

- Water Resistant
- Heart rate meter
- Sleep monitoring
- Connection to mobile device's playlist
- Alarm clock
- Mobile Phone Notifications

## THIKER II 97431

The THIKER II is a modern smart watch with leather strap that suits different occasions due to its elegant design. THIKER II is supplied in a gift box.

26 x 47 x 8 mm | Box: 120 x 120 x 70 mm

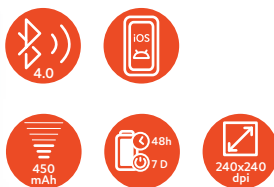

- GPS
- Water Resistant
- Heart rate meter
- Sleep monitoring
- Connection to mobile device's playlist
- Mobile Phone Notifications

## METRONOME 97429

The METRONOME is a modern and sophisticated smart watch with details that give it a timeless yet innovative design. The integrated GPS and its water resistance enhance the uniqueness of this smart watch that is supplied in a gift box.

26 x 50 x 10 mm | Box: 120 x 120 x 70 mm







A5

**DYNAMIC NOTEBOOK**

**93597**

The DYNAMIC is an A5 notebook thought and designed to be a functional and practical object with a touch of city elegance. It has two different writing notepads on each side that can be used and closed separately. It has a magnet closing system on the strap that goes around the notepad. The band has a different colour on each side, allowing its identification, giving a certain irreverence to the product. The exterior material is high quality imitation leather and 168D, textured and smooth. It has 256 pages that are divided proportionally between plain and lined pages, identifiable by the outer banner. The DYNAMIC notepad is unique in its design but also in its functionality, where duality makes it a perfect object for every moment of everyday life.



150 x 210 mm | Box: 197 x 250 x 28 mm

HTS - 35 x 10 mm





**A5 GEOMETRIC NOTEBOOK**

**93596**

The GEOMETRIC is an A5 hard cover imitation leather notepad. The design of the cover was inspired by geometric figures based on optical illusion patterns. The elastic band, which allows to close the notepad, the bookmark and the pen holder (pen not included) reinforce the usefulness of this notepad. More than a notepad, it is a support for communicating emotions. Something very personal and unique.

140 x 210 mm | Box: 177 x 250 x 24 mm  
HTS - 40 x 30 mm

**A5 TILES NOTEBOOK**

**93737**

The TILES is an A5 hard cover imitation leather notepad with 256 lined pages inside. This whole notepad was designed based on cultural elements, in this case the Portuguese tiles. The elastic band that closes the notepad, bookmark and pen holder (pen not included) reinforces the usefulness of this notebook. More than a notepad, it is a support for communicating emotions. Something very personal and unique.

140 x 210 mm | Box: 177 x 250 x 24 mm  
HTS - 40 x 30 mm



A5

**EMPIRE NOTEBOOK****93598**

The EMPIRE is an A5 notepad with a modern and minimalist design and with a business touch. The hard cover with split leather with PU that protects the interior, which intelligently splits into three distinct parts with a separator that allows you to identify each part. Its 240 pages are proportionally divided into plain, lined and dotted pages. Its minimalist design is complemented by the metallic detail on the closure, which is characteristic of this product line and enhances its elegance. The product is supplied with a pen holder (pen not included) and in a gift box.



✂ 150 x 210 mm | Box: 197 x 250 x 28 mm

✂ HTS - 35 x 10 mm





**PORTEL • 93480**

A5 cork notepad with 160 plain ivory pages.  
This product is supplied in a non-woven pouch.



137 x 215 mm | Pouch: 185 x 240 mm  
✂ LSR - 90 x 100 mm

**PORTEL • 93488**

Cork notepad with 160 plain ivory pages. This product is supplied in a non-woven pouch.



97 x 145 mm | Pouch: 130 x 165 mm  
✂ LSR - 60 x 90 mm

**ADAMS • 93719**

A5 cork notepad with 160 plain ivory pages.



140 x 210 mm  
✂ SCR - 110 x 180 mm

**ADAMS • 93720**

Pocket size cork notepad with 160 plain ivory pages.



90 x 142 mm  
✂ SCR - 60 x 90 mm

**DICKENS • 93485**

A5 spiral bamboo notepad with 140 lined recycled pages.  
This product includes a bamboo ballpoint.



135 x 180 mm  
✂ PDP - 30 x 50 mm

**DICKENS • 93486**

Spiral bamboo pocket size notepad with 140 lined recycled pages. This product includes a bamboo ballpoint pen.







105 x 148 mm  
✂ LSR - 55 x 118 mm





**A5** **TORDO • 93593**

 A5 notepad with hard cover in cork and PU, with 192 ivory pages.  
 This product contains a pen holder (pen not included) and is supplied in a non-woven pouch.

 140 x 210 mm  
 SCR - 80 x 180 mm



# ATTENTION TO THE DETAIL

This stylish notepad features magnetic closure and ivory sheets.



A5

## LISPECTOR • 93724



A5 imitation leather notepad with hard cover and magnetic closure. This elegant notepad contains a pen holder and 192 plain ivory pages. This customisable product is provided in a non-woven pouch. Ballpoint not included.

📏 148 x 210 mm | Pouch: 185 x 240 mm  
✂️ TRS - 70 x 180 mm



A5

## MORAES • 93714



Set with WASS aluminum ballpoint with iron clip and A5 notepad with hard cover, inside pocket and 160 ivory lined pages. This set is supplied in a gift box.



📏 Ball pen: Ø10 x 138 mm | Notepad: 137 x 210 mm |  
Box: 190 x 240 x 30 mm  
✂️ SCR - 100 x 190 mm



A5

## CHAUCER • 93497



A5 hard cover notepad imitation leather with 192 plain pages. This notepad includes a metal ballpoint pen and is supplied in a gift box.



📏 139 x 216 mm | Box: 145 x 220 x 15 mm  
✂️ SCR - 70 x 150 mm



13

13

A5

**RUSSEL • 93788**



Imitation leather and polyester folder with A5 notepad inside. This folder contains magnetic closure, outer pocket, inner pocket and pen holder (pen not included). The removable notepad contains 160 plain pages. This customisable product is provided in a non-woven pouch.

☒ 155 x 215 mm | Pouch: 205 x 250 mm  
 ✂ SCR - 70 x 160 mm



A5

**PESSOA • 93734**



Polyester cover with notepad inside. The cover contains inside pocket and pen holder. The removable notepad has 160 plain pages. This customisable case comes in a non-woven bag. Pen not included.

☒ 160 x 220 mm | Pouch: 205 x 250 mm  
 ✂ TRS - 95 x 80 mm



With ball pen holder



A5

**SHAKESPEARE • 93789**



A5 imitation leather notebook with hardcover, pen holder (pen not included) and 280 plain ivory pages. This product is supplied in a non-woven pouch.

145 x 210 mm | Pouch: 185 x 240 mm  
SCR - 80 x 150 mm



With ball pen holder

A5

**MORIAH • 93799**



A5 notepad with 192 lined pages with ball pen support (pen not included).

140 x 210 mm  
HTS - 30 x 60 mm



13

A5

**CARREY • 93725**



A5 hardcover canvas (polyester) notepad with ballpoint holder (not included) and 192 plain ivory pages. This product is supplied in a non-woven pouch.

148 x 210 mm | Pouch: 185 x 240 mm  
 TRS - 95 x 140 mm



04

A5

**DENIM • 93594**



A5 notepad with hard cover lined in denim fabric with 192 lined pages. This notepad has no inner pocket and ball pen holder (pen not included).

140 x 210 mm  
 TRS - 90 x 180 mm



11

04

05

13



A5

**HUGO • 93591**



A5 notepad with rigid polyester lined cover and 190 lined ivory pages.

137 x 210 mm  
 TRS - 90 x 180 mm



**A5** **KAFKA • 93712**

**A5** A5 notepad in imitation leather, hard cover and 160 plain pages. This customisable product is provided in a non-woven pouch. Pen not included.  
 150 x 210 mm | Pouch: 185 x 240 mm  
 SCR - 35 x 160 mm



**A5** **ROOTS • 93713**

**A5** A5 notepad in imitation leather with 192 plain pages. This product is supplied in a non-woven bag. Pen not included.  
 140 x 210 mm | Pouch: 185 x 240 mm  
 SCR - 100 x 120 mm

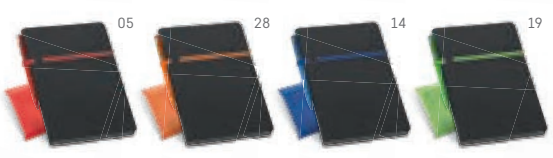

**A5** **DUMAS • 93716**



**A5** A5 notepad in imitation leather with 192 plain pages and pen holder. This product is supplied in a non-woven pouch. WASS ballpen included.  
 Notepad: 140 x 210 mm | Ball pen: Ø10 x 138 mm |  
 Pouch: 185 x 240 mm  
 SCR - 120 x 120 mm



**A5 SHAW • 93795**

 A5 imitation leather notepad and ballpoint pen set with 160 plain pages. This customisable set is supplied in a PP gift box.



 Ball pen: Ø10 x 137 mm | Notepad: 140 x 210 mm |  
 Box: 155 x 214 x 13 mm  
 SCR - 100 x 180 mm

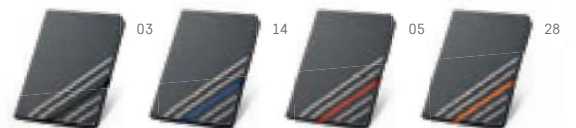

**A5 PLOT • 93790**

 A5 imitation leather notepad with hardcover and 160 plain pages. This product is supplied in a non-woven pouch.

 150 x 210 mm | Pouch: 185 x 240 mm  
 SCR - 50 x 100 mm



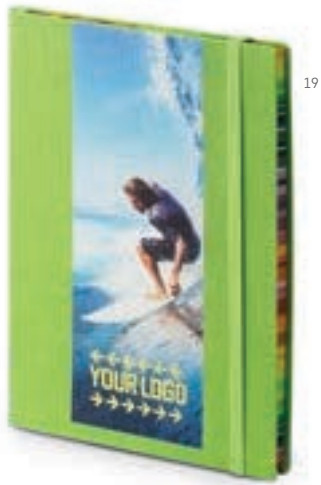

19

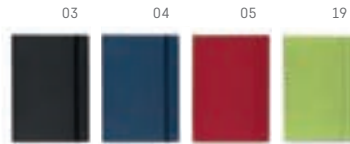

**A6** **BERGSON • 93736**  
 A6 notepad with 200 pages, rainbow edged pages and elastic.  
 90 x 140 mm  
 PDP - 30 x 50 mm



28

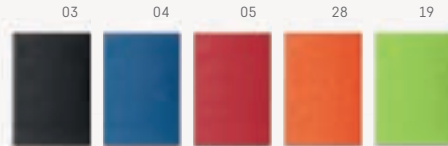

**A5** **ELIANA • 53413**  
 A5 notepad with 160 lined pages with flexible cover.  
 140 x 210 mm  
 HTS - 50 x 30 mm



19

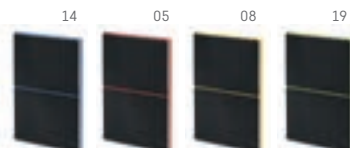

**A5** **BLOGGER • 53396**  
 A5 note pad with 200 lined pages and horizontal elastic.  
 145 x 210 mm  
 SCR - 110 x 80 mm

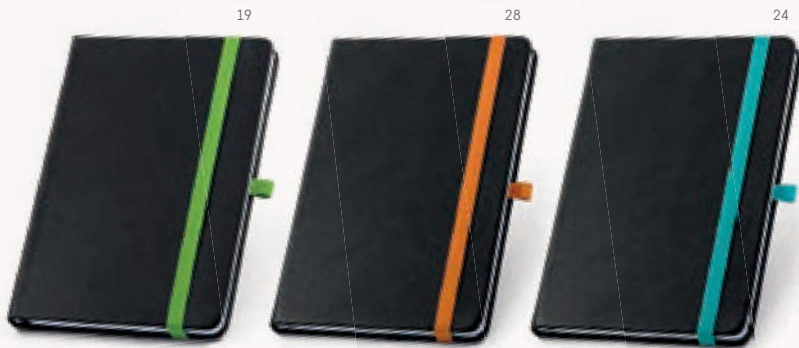

Inside pocket



Lined sheets



**ROTH • 93592**

A5 hard cover notepad with 160 pages. This product contains a paper pocket on the back of the cover and a pen holder (pen not included).

140 x 210 mm  
 LSR - 90 x 180 mm

Laser customisation



Inside pocket

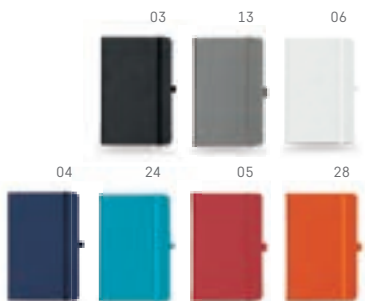

Lined sheets



**LANYO II • 93590**

A5 notebook with 192 lined pages, elastic, inside pocket and pen holder (pen not included).

132 x 213 x 18 mm  
 SCR - 95 x 180 mm





14

19



Inside pocket

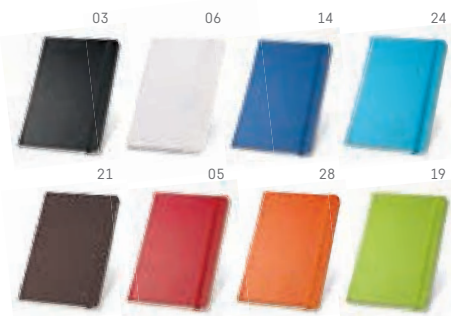

03

06

14

24

21

05

28

19



Lined sheets

A5

**TWAIN • 93494**



A5 notepad with 160 ivory pages, inner pocket and hard cover.

137 x 210 mm  
SCR - 100 x 180 mm



24



05

28

04

24



Plain sheets

A5

**JOYCE • 93733**



A5 notepad 160 plain ivory pages with pen holder (pen not included).

137 x 210 mm  
SCR - 100 x 180 mm



05



Lined sheets

A5

**LINKED • 53423**



A5 notepad with 160 ivory lined pages. Elastic and ball pen holder (pen included).

132 x 215 x 16 mm  
HTS - 50 x 30 mm

03

05



Dotted sheets

03



Inside pocket

A5

**CARRE • 93595**



A5 hardcover notepad with 190 dotted pages. This notepad has an inner pocket and ball pen holder (pen not included).

137 x 210 mm

SCR - 100 x 190 mm



Inside pocket

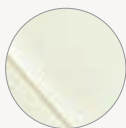

Plain sheets

A5

**PORTMAN • 93775**



A5 notepad with 160 plain ivory pages, inside pocket and hard metallic cover (gold or silver).

137 x 210 mm

SCR - 100 x 190 mm



37

27



Inside pocket



Plain sheets

A5

**CHAMBERI • 93491**



A5 notepad with 160 plain ivory pages and hard cover, inside pocket and pen holder (pen not included).

137 x 210 mm

SCR - 100 x 190 mm



03



05

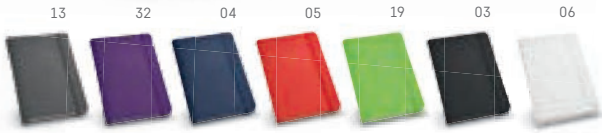

Plain sheets

**A5 HEMINGWAY • 93487**

A5 notepad with 160 plain pages with imitation leather. Hard cover.  
 140 x 210 mm  
 SCR - 80 x 150 mm



08



Lined sheets

**B6 BRISA • 53414**

Notepad with 160 lined pages supplied with bookmark.  
 130 x 170 mm  
 HTS - 50 x 30 mm



24



Lined sheets

**pocket BECKETT • 93732**

Pocket size notepad with 160 lined pages and imitation leather hard cover.  
 90 x 140 mm  
 SCR - 50 x 80 mm



19



Plain sheets

**pocket MEYER • 93425**

Pocket size notepad with 160 plain sheets and hard cover imitation leather.  
 90 x 140 mm  
 SCR - 50 x 100 mm

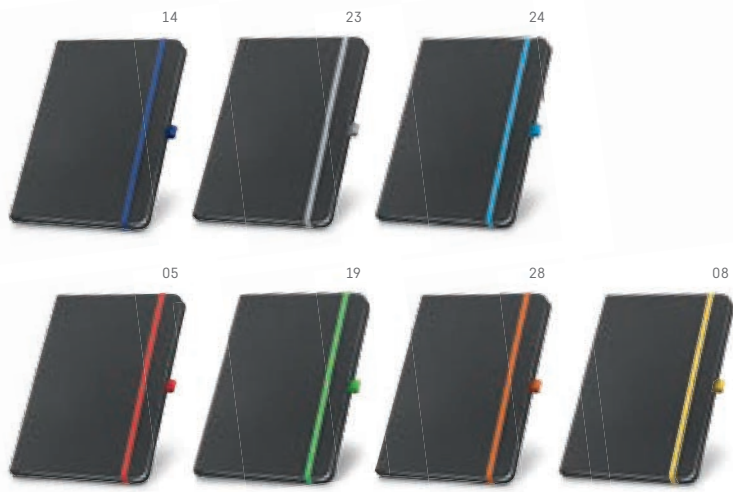

**A5 CORBIN • 93717**  
 A5 notepad in imitation leather with hard cover and 160 lined pages and pen holder (pen not included).  
 140 x 210 mm  
 SCR - 100 x 180 mm

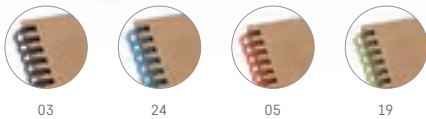

03 24 05 19



### GARDEN • 93708



B6 spiral notepad with 120 lined recycled pages and hard cardboard cover with pen holder (pen not included).



140 x 180 mm  
SCR - 50 x 80 mm

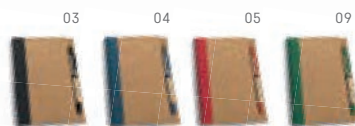

03 04 05 09



### ASIMOV • 93715



B6 spiral notebook with 120 plain recycled pages and craft hardcover. This notebook includes a pen holder and ballpoint.



130 x 177 mm  
SCR - 70 x 160 mm

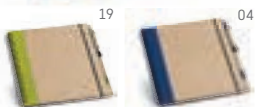

19 04



### PLATH • 93429



Spiral notepad with 120 plain recycled pages and hard cardboard cover. This product includes a pen holder and ballpoint.



154 x 154 mm  
SCR - 130 x 80 mm



04 05 19



### RINGORD • 93427



Pocket size notepad with 120 plain recycled pages and hard cardboard cover. This notepad includes a pen holder and ballpoint.



105 x 145 mm  
SCR - 80 x 90 mm



# PAPER STONE

- ✔ Smooth texture
- ✔ Waterproof
- ✔ Resistant
- ✔ Ecological

MATCH YOUR ROCK NOTEPAD WITH THE DEVIN BALL PEN (PG. 133)

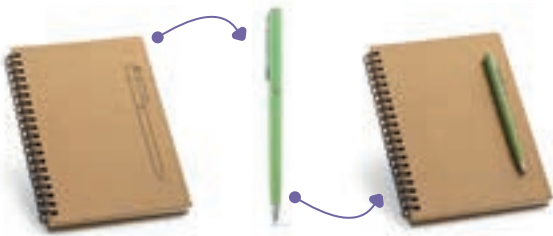

**B6** **ROCK** • 93419

B6 hardcover notepad with craft paper cover and 140 smooth pages of 120g/m<sup>2</sup> stone paper. This notepad has a magnet on its cover that is a ball pen holder (pen not included).

130 x 180 mm

SCR - 70 x 160 mm



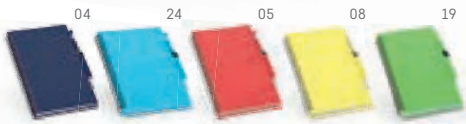

**ROTHFUSS • 93482**



B6 notepad with 160 lined recycled pages, with hard cover and pen holder.



125 x 180 mm



SCR - 90 x 140 mm

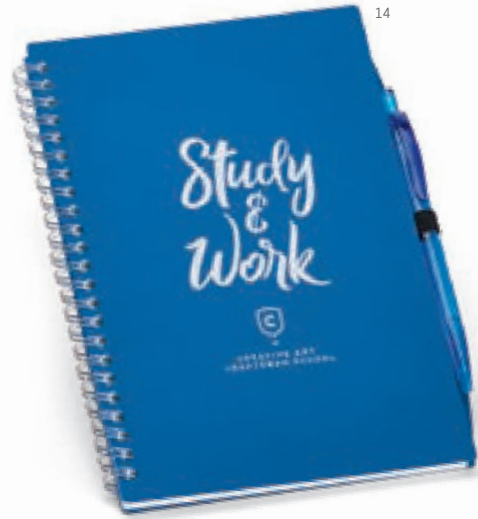

**MIRONTE • 93498**



A5 spiral notepad with 140 lined pages in PP semi-rigid and with pen holder.



150 x 210 mm



SCR - 90 x 150 mm

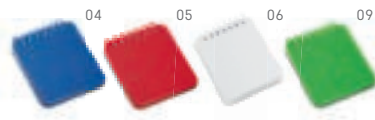

**WOOLF • 93710**



Spiral notepad with 80 plain recycled pages and semi-rigid PP cover.



70 x 80 mm



SCR - 50 x 50 mm



**MILTON • 93476**



A7 spiral notepad with 170 plain pages and semi-rigid PP cover.



78 x 108 mm



SCR - 30 x 60 mm



**A5** **ECOWN • 93495**

 A5 notepad with 80 lined pages and cardboard cover.  
 140 x 210 mm  
 SCR - 100 x 150 mm



 **KOSTOVA • 93439**

 A5 notepad with 80 lined recycled pages and cardboard cover with inside pocket.  
 144 x 210 mm  
 SCR - 85 x 160 mm



Inside pocket

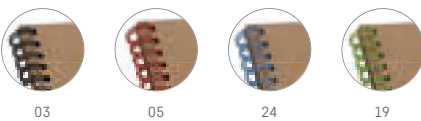

 **MARLOWE • 93707**

 Spiral pocket notepad with 120 lined recycled pages and rigid cardboard cover.  
 100 x 140 mm  
 SCR - 50 x 120 mm



 **FLAUBERT • 93709**

 Pocket notepad with 160 plain recycled pages and hard cardboard cover.  
 100 x 140 mm  
 SCR - 60 x 110 mm



19



05

24

19



60

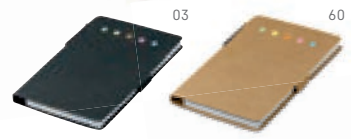

03

60

ADAPTABLE

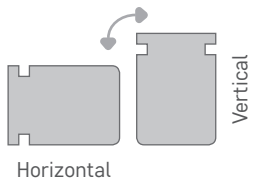

**WILDE • 93711**  
 B7 B7 notepad with 120 plain recycled pages and cardboard cover.  
 85 x 125 mm  
 SCR - 60 x 80 mm



**COOPER • 93791**  
 Sticky notes set with 6 sets (25 sheets each). This set also includes a 100-pages notepad and the ballpoint (craft paper).  
 100 x 150 mm  
 SCR - 60 x 100 mm



60

**BRONTE • 93422**  
 A7 notepad with 140 plain recycled pages and hard cardboard cover. This notepad includes a pencil.  
 82 x 105 mm  
 SCR - 40 x 80 mm



60

**BULFINCH • 93461**  
 B7 notepad with 60 plain recycled pages and cardboard cover.  
 93 x 125 mm  
 SCR - 70 x 100 mm



60



**ELIOT • 93792**

Office set with notepad (160 recycled pages), 6 sets of sticky notes (25 sheets each), 12 cm ruler, 1 ballpoint (craft paper), business card holder and cardboard cover.



110 x 153 mm



PDP - 30 x 50 mm



05



04



05



**GIFFER • 53428**

Set with A5 notepad with 120 lined pages, sticky notes (25 per colour), plastic ruler, wooden ruler, ball pen, two graphite pencils, wood sharpener and eraser.

152 x 210 x 25 mm

SCR - 120 x 180 mm

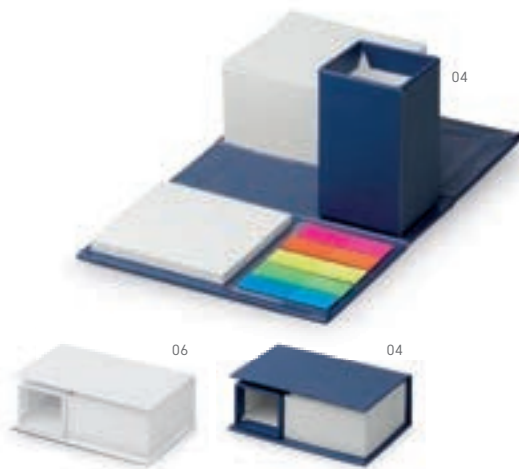

04

06

04

**SHENNA • 53434**

Sticky note set with cardboard ball pen holder. This office set includes 1 notepad with 75 x 75mm sheets (380 sheets), 5 sets of neon coloured sticky notes (25 sheets each colour) and 68 x 74mm white sticky note (50 sheets).

128 x 82 x 52 mm

PDP - 50 x 35 mm

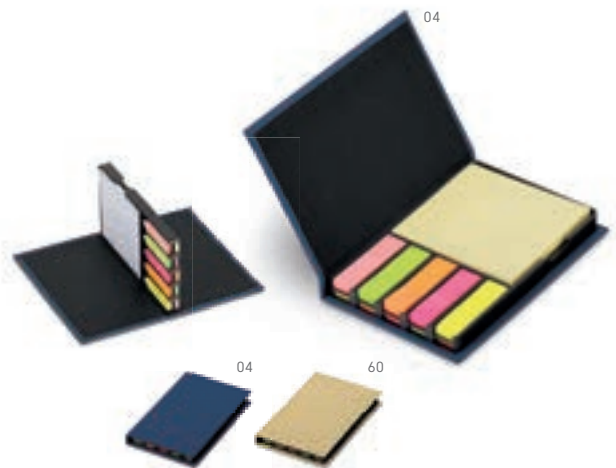

04

04

60

**LOVECRAFT • 93793**

Sticky notes set with 12 sets (40 sheets each) and cardboard cover.

85 x 132 x 15 mm

PDP - 15 x 50 mm



### **PETER • 93718**

Spiral sticky notes set with 6 sets (25 sheets each set) and paper craft cover.

⌈ 75 x 70 mm  
 ↘ SCR - 50 x 45 mm



### **STOOKY • 93421**

Sticky notes set with 5 sets (25 sheets each set) and hard cover.

⌈ 80 x 60 x 3 mm  
 ↘ SCR - 60 x 30 mm



### **MISU • 53388**

5 set neon coloured sticky notes (25 sheets per set).

⌈ 75 x 50 mm  
 ↘ STI - 60 x 40 mm



### **JAMES • 93448**

Sticky notes set with 7 sets (25 sheets each set) and 12 cm ruler (printed scale).

⌈ 159 x 50 x 3 mm  
 ↘ SCR - 130 x 12 mm



### **LEWIS • 93426**

Sticky notes set with 7 sets (25 sheets each set) and cardboard cover.

⌈ 80 x 105 x 9 mm  
 ↘ SCR - 50 x 80 mm



60



03

06

60

### TAZY • 93735

6 set coloured sticky notes (22 sheets per set) with card slot.

∩ 104 x 65 x 5 mm  
 ✂ SCR - 30 x 50 mm



60



06

03

60

### FAULKNER • 93794

Triangular sticky notes set with 4 sets (25 sheets each) and cardboard cover.

∩ 91 x 91 mm  
 ✂ PDP - 50 x 25 mm



93621

KIDS  
 PG. 416

### AUSTEN • 91917

TPR rubber.  
 ∩ 55 x 22 x 12 mm  
 ✂ DUV - 40 x 15 mm



06



04

05

28

08

### SIZA • 91935

TPR rubber with PP protection cover.

∩ 55 x 33 x 13 mm  
 ✂ PDP - 20 x 15 mm



04

19

**SUNDERLAND • 93518**

Ruler with 15 cm printed scale and magnifying glass.

▮ 185 x 45 x 3 mm

♣ SCR - 120 x 25 mm

**STEPHENIE • 93565**

Ruler with 15 cm printed scale and clip.

▮ 174 x 31 x 2 mm

♣ SCR - 55 x 8 mm

**RULER • 93576**

30 cm ruler.

▮ 305 x 32 x 3 mm

♣ PDP - 60 x 10 mm



MADE IN EUROPE

**WILLIAM • 93531**

PS ruler with 15 cm embossed scale.

▮ 163 x 25 x 3 mm

♣ SCR - 150 x 10 mm

**FREDERICK • 93532**

PS ruler with 20 cm embossed scale.

▮ 211 x 28 x 2 mm

♣ SCR - 180 x 13 mm

**BECKY • 93533**

PS ruler with 25 cm embossed scale.

▮ 259 x 30 x 3 mm

♣ SCR - 235 x 16 mm

**ARTHUR • 93553**

PS ruler with 30 cm embossed scale.

▮ 309 x 32 x 2 mm

♣ SCR - 280 x 18 mm

HOW TO ORDER YOUR BUTTON P'IN: PG. 510



BUTTON P'IN

HOW TO ORDER YOUR DOM'ING: PG. 512



DOM'ING



**WHITMAN • 93359**

PVC badge holder.  
 110 x 170 mm  
 SCR - 15 x 50 mm



**FORSYTH • 93357**

PVC badge holder.  
 110 x 90 mm  
 PDP - 50 x 15 mm

**YEATS • 53569**

Badge reel extendable up to 900 mm and with a metal clip.  
 Ø32 x 9 mm  
 PDP - 15 x 15 mm



**STAND • 81138**

Ball pen with ABS holder, with sticker on the base to stick to surface.  
 60 x 160 x 60 mm |  
 Ball pen: 11 x 11 x 141 mm  
 PDP - 6 x 50 mm



**SLOPE • 81150**

Ball pen with ABS holder, with sticker on the base to stick to surface.  
 90 x 140 x 102 mm |  
 Ball pen: Ø9 x 139 mm  
 PDP - 20 x 50 mm







Adaptable to any structure



Modern design

LED  
COB

### NESBIT • 94743

ABS desk lamp with LED COB. This practical and modern lamp with clip, flexible arm and tactile button with 3 light modes (low, medium and strong) has a battery life of up to 20 h, includes a USB charging cable and is supplied in a box.

⊥ 115 x 55 x 380 mm  
↗ PDP - 50 x 20 mm



Directional light

Bluetooth

### GRAHAME • 94744

LED

ABS Desk lamp with speaker. This elegant and bold lamp features 18 high-brightness LEDs, tactile knob and flexible arm. It allows bluetooth transmission, 3.5 mm stereo connection, with 5W/4Ω and has autonomy up to 6 h. Besides its portability, it also allows a connection to the mobile device's playlist and includes USB cable for charging. This product is supplied in a gift box.

⊥ 100 x 225 x 100 mm | Box: 110 x 235 x 105 mm  
↗ PDP - 12 x 50 mm



### OSCAR • 92075



A5 imitation leather folder with built-in portable battery (lithium). This folder includes a pen holder (pen not included) and a removable notepad with 64 lined ivory sheets. The battery has a capacity of 4,000 mAh, lifetime  $\geq$  500 cycles, with 5V/1A input/output and USB/micro USB cable to charge the battery. The folder contains elastics inside for organizing and support for smartphone and, on the outside, a rubber-finished plate with interior LED and on/off button. This product is supplied in a gift box.

▮ 165 x 225 x 25 mm | Plate: 55 x 35 mm | Box: 180 x 240 x 35 mm

✂ LSR - 25 x 30 mm



Backlit  
board



**SALINGER • 92068**

A4 folder in imitation linen and imitation leather. This folder contains, on the outside, a metal plate with rubber finish. Inside it contains a pad (20 lined sheets), pen holder (not included) and other compartments (accessories not included).

▮ 259 x 336 x 27 mm | Plate: 50 x 30 mm  
 ⚡ LSR - 25 x 40 mm



**RIORDAN • 92067**

A4 folder in imitation linen and imitation leather and magnetic closure. Inside contains a notepad of 20 sheets lined inside, a ballpoint holder (not included).

▮ 233 x 310 x 18 mm | Plate: 50 x 30 mm  
 ⚡ LSR - 25 x 40 mm



**PYNCHON • 92066**

A5 folder in imitation linen and imitation leather with magnetic closure. This folder includes a 20-sheet lined pad, pen holder (pen not included) and other compartments (accessories not included).

▮ 183 x 252 x 18 mm | Plate: 50 x 30 mm  
 ⚡ LSR - 25 x 40 mm





### SERPA • 92069



A4 cork folder with a notepad of 20 plain ivory sheets with pen holder (pen not included). This product is supplied in a non-woven pouch.

239 x 307 x 17 mm | Pouch: 285 x 350 mm

SCR - 100 x 100 mm



60



03



### CHRISTIE • 92058

A4 folder in leather imitation and microfiber. This folder includes a notepad of 20 lined sheets and 4 x 20 mm rings ideal for A4 sheets.

265 x 340 x 45 mm

SCR - 20 x 80 mm



23



### AUSTER • 92073

600D A4 folder with front outer pocket, 4 inner 20 mm ring loops to place A4 sheets. This folder includes a pad with 20 lined sheets.

260 x 340 x 35 mm

TRS - 150 x 160 mm



 **PASZO • 92044**

A4 folder, imitation leather and microfiber. This folder contains a notepad of 20 lined sheets and pen holder (pen not included)  
 245 x 325 x 40 mm | Plate: 16 x 45 mm  
 TRS - 150 x 250 mm

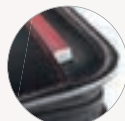

05

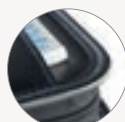

04

 **BIELO • 92038**

A4 imitation leather folder with front pocket and zipper. Inside includes a 20-sheet lined notepad and 8-digit dual-power calculator with LR1130 battery included.  
 250 x 345 x 20 mm  
 SCR - 150 x 200 mm



 **GORDON • 92032**

A4 Imitation leather folder that includes a notepad of 20 lined sheets and contains pen holder (pen not included). This folder also includes an 8-digit dual-power calculator with LR1130 battery (included).  
 240 x 320 x 32 mm  
 SCR - 90 x 100 mm



23

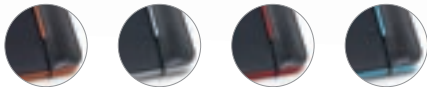

28

23

05

24



**FITZGERALD • 92040**

A4 folder, imitation leather and 800D and microfiber interior. The folder includes a 20-sheet lined notepad, inner pocket and pen holder (pen not included).

☒ 245 x 315 x 15 mm  
 ✂ TRS - 150 x 250 mm



23



23

14

05

19

28



**TORGA • 92072**

A4 folder, microfiber and 210D. This folder includes a pad of 20 lined sheets and a pen holder (pen not included).

☒ 240 x 315 x 15 mm  
 ✂ TRS - 200 x 200 mm



04



04

03



**CUSSLER • 92049**

600D A4 folder with 20-sheet lined pad and pen holder (pen not included).

☒ 240 x 320 x 10 mm  
 ✂ TRS - 190 x 230 mm



15



15

04

23



**CLARK • 92041**

A4 folder in 600D, with elastic closure. This folder contains a 20-sheet lined pad and pen holder (pen not included).

☒ 240 x 325 x 15 mm  
 ✂ TRS - 110 x 150 mm



**POE • 92046**  
 Cardboard A4 folder (450 g/m<sup>2</sup>). This folder includes a 20 plain recycled sheets, a pen holder and pen.  
 230 x 320 x 15 mm  
 PDP - 30 x 50 mm



**DURRELL • 92071**  
 A5 cardboard folder (450 g/m<sup>2</sup>). This folder contains a pad of 20 plain recycled sheets, a pen holder and includes ballpoint.  
 168 x 230 x 15 mm  
 PDP - 30 x 50 mm



**PUZO • 93463**  
 A4 cardboard folder (400 g/m<sup>2</sup>)  
 230 x 307 mm  
 SCR - 100 x 150 mm







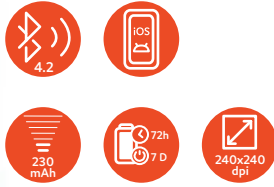

- Water Resistant
- Heart rate meter
- Sleep monitoring
- Connection to mobile device's playlist
- Alarm clock
- Mobile Phone Notifications

## THIKER I 57431

The THIKER I is a sophisticated water resistant smart watch with stainless steel strap. The THIKER I is a watch with features that allow it to be an ally for everyday life and is supplied in a gift box.

26 x 47 x 8 mm | Box: 120 x 120 x 70 mm

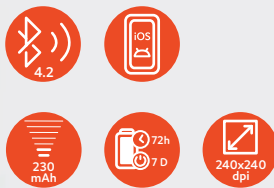

- Water Resistant
- Heart rate meter
- Sleep monitoring
- Connection to mobile device's playlist
- Alarm clock
- Mobile Phone Notifications

## THIKER II 97431

The THIKER II is a modern smart watch with leather strap that suits different occasions due to its elegant design. THIKER II is supplied in a gift box.

26 x 47 x 8 mm | Box: 120 x 120 x 70 mm

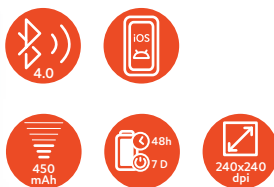

- GPS
- Water Resistant
- Heart rate meter
- Sleep monitoring
- Connection to mobile device's playlist
- Mobile Phone Notifications

## METRONOME 97429

The METRONOME is a modern and sophisticated smart watch with details that give it a timeless yet innovative design. The integrated GPS and its water resistance enhance the uniqueness of this smart watch that is supplied in a gift box.

26 x 50 x 10 mm | Box: 120 x 120 x 70 mm





- Microphone
- Call button
- Connection to mobile device's playlist
- Includes a cable



## BLARE 97257

The BLARE is a modern and discreet ABS design speaker. The speaker is an object that becomes a partner at all times due to its technical and functional characteristics. The BLARE is supplied in a gift box.

▮ 60 x 63 x 70 mm | Box: 120 x 139 x 83 mm  
 ↗ PDP - 20 x 40 mm



**THUNDER**  
**97258**

The THUNDER is a textured fabric ABS speaker elegant and with detailed finishings. The speaker is an object that fits perfectly into a stylish and sophisticated environment and is supplied in a gift box.

▮ 73 x 196 x 54 mm | Box: 275 x 123 x 74 mm  
 ⚡ SCR - 40 x 15 mm

- Microphone
- Volume control
- Call button
- Connection to mobile device's playlist



18 high brightness LEDs

Connection with smartphone



Directional light

Speaker with bluetooth transmission



**GRAHAME • 94744**



ABS Desk lamp with speaker. This elegant and bold lamp features 18 high-brightness LEDs, tactile knob and flexible arm. It allows bluetooth transmission, 3.5 mm stereo connection, with 5W/4Ω and has autonomy up to 6 h. Besides its portability, it also allows a connection to the mobile device's playlist and includes USB cable for charging. This product is supplied in a gift box.



100 x 225 x 100 mm | Box: 110 x 235 x 105 mm  
PDP - 12 x 50 mm



03



Removable display for charging



**MENDEL • 97425**

Smart bracelet in silicone and ABS. The strap has a touch button and allows bluetooth transmission. With this bracelet you can receive notification for phone calls, text messages, task and activity reminders. This product has clock, calendar, alarm clock, pedometer, walking distance meter, calorie counter, heart rate and blood pressure meter, sleep monitoring, anti-sedentary warning, anti-loss alarm, camera remote control and has autonomy up to 15 days. The flexible strap is adjustable up to 9 positions, includes USB charging cable and is compatible with Android and iOS. Application download is possible from the Play Store and the AppStore. This product is supplied in box.

20 x 240 x 9 mm | Box: 78 x 103 x 24 mm  
DGL - 40 x 60 mm



03



**NICOLLE • 97424**

Silicone smart watch with OLED touch screen and bluetooth transmission. This watch allows you to receive notification of phone calls and text messages. In addition to a clock, the product also has the functions of: calendar, alarm clock, stopwatch, pedometer, sleep time monitoring, thermometer, barometer, call history and contact list access, handsfree kit and connection to device's playlist. This product has autonomy up to 15 h. Its flexible strap is adjustable up to 11 positions. The NICOLLE smart watch includes a USB/micro USB cable for charging and is compatible with Android and iOS and can be downloaded from the Play Store (iOS devices do not require an app). This product is supplied in a box.

40 x 252 x 12 mm | Box: 75 x 92 x 57 mm  
PDP - 3 x 10 mm



13



### TEDS • 97208

Speaker with ABS microphone, polyester fabric and rubber finish. This speaker allows bluetooth transmission, 3.5mm stereo connection and TF card reading. It has 2 x 3W / 4Ω and autonomy up to 4 h. The OERSTED column also allows the function to answer calls, control the volume and connect to the mobile device playlist. Includes USB cable for charging and is supplied in a gift box.

∓ 160 x 120 x 50 mm | Box: 180 x 180 x 66 mm  
 ↗ SCR - 120 x 120 mm



19

19

03



### ECCLES • 97385

ABS and polyester fabric speaker with microphone. The speaker includes a hook, rubber finish and allows for 3W/4Ω bluetooth transmission. The ECCLES speaker has autonomy up to 3 h, call answering, volume control and mobile device playlist connection. This product includes a charging cable and is supplied in a gift box.

∓ Ø90 x 40 mm | Box: 115 x 95 x 45 mm  
 ↗ DGL - 40 x 20 mm



### GANTE • 97395

Speaker with microphone in ABS, polyester fabric and rubber finish. This speaker allows bluetooth transmission, 3.5mm stereo connection and TF card reading. It has 3W/4Ω and autonomy up to 2 h. Answer calls, control volume, connect to mobile device's playlist and FM radio are some of the features of this speaker. The speaker includes a USB cable for charging and is supplied in a gift box.

∓ 120 x 80 x 40 mm | Box: 142 x 85 x 45 mm  
 ↗ DGL - 60 x 40 mm



13



### SYNTH • 97927

Speaker with bluetooth transmission and microphone supplied in gift box. The technical characteristics of the speaker are the following: 3W, 10m Bluetooth 4.0 transmission, 520mAh battery capacity, 2-3 hours charging time, up to 8 hours autonomy, built-in microphone for phone and conference calls, start button/stop directly on speaker, FM radio capability. This product is compatible with all devices with Bluetooth transmission connectivity as well as sound cable. Includes 5V USB/DC cable/Jack.

∅ 60 x 50 mm | Box 97 x 87 x 95 mm

LSR - 20 x 20 mm



06



03



03



### HOYLE • 97335

ABS speaker with microphone, bluetooth transmission, 3.5mm stereo connection, TF card reader, with 3W/4Ω and autonomy up to 3h. It includes functions such as call answering, volume control and connection to the mobile device playlist and has non-slip support for mobile phones. This product includes a USB charging cable and is supplied in a gift box.

∅ 85 x 66 mm | Box: 93 x 93 x 85 mm

PDP - 20 x 10 mm



### WRIST • 45327

Wristwatch speaker with bluetooth transmission. The speaker has 3W of power, 2.1 bluetooth transmission up to 10m range, 250 mAh battery capacity, 3-4h charging time, up to 3 hours autonomy, built-in play/stop button and SD card slot. This promotional product is compatible with all devices that support bluetooth transmission. Includes USB/micro USB Cable.

∅ 47 x 24 x 70 mm

PDP - 20 x 7 mm





### EDISON • 97255

Speaker with 4.2 bluetooth transmission and customizable with an illuminated logo. This rubber finished ABS speaker has micro-USB port and a 300mAh battery. This battery includes 2 in 1 cable: USB - micro USB for charging and micro USB.

⊕ 59 x 59 x 51 mm  
 ✂ LSR - 30 x 15 mm



### FLOREY • 97252



Aluminum speaker with microphone, bluetooth transmission and TF card reader, 3W/4 power and autonomy up to 5h. Functions: answering calls, volume control, connection to mobile device's playlist and FM radio. This product includes micro USB cable for charging and is supplied in a gift box.

⊕ Ø71 x 42 mm | Box: 80 x 80 x 60 mm  
 ✂ PDP - 25 x 15 mm



**CURIE • 57328**

ABS waterproof speaker with matt finish. This speaker allows bluetooth transmission. It has power of 3W/4Ω and autonomy up to 3h. Its features include answering calls, controlling volume and connecting to the mobile device's playlist. Includes suction cup and charging cable. This column is supplied in a gift box.

∓ Ø85 x 50 mm | Box: 88 x 88 x 55 mm  
 ↗ PDP - 30 x 9 mm



**TURING • 97333**

ABS mini speaker with microphone, with bluetooth transmission and 3.5mm stereo connection, with 2W/4Ω and autonomy up to 4h. It includes the function to answer calls, volume control and connection to the mobile device playlist. This product includes a USB charging cable and is supplied in a gift box.

∓ Ø35 x 38 mm | Box: 65 x 65 x 45 mm  
 ↗ PDP - 10 x 25 mm



**KEPLER • 97386**

ABS speaker with microphone and rubber finish. This product allows bluetooth transmission, 3.5mm stereo connection and TF card reading. It has power of 3W/4Ω and autonomy up to 3 h. It has the following functions: answer calls, control volume, connect to mobile device playlist and FM radio. Includes USB cable for charging and is supplied in a gift box.

∓ 108 x 55 x 38 mm | Box: 130 x 58 x 40 mm  
 ↗ PDP - 35 x 15 mm



**EUCLID • 97340**

ABS speaker with microphone and rubber finish. This speaker allows bluetooth transmission, has power of 3W/4Ω and autonomy up to 3h. Allows you to answer calls, control volume and connect to your mobile device playlist. Includes USB cable for charging and is supplied in a gift box.

∓ 150 x 56 x 58 mm | Box: 155 x 61 x 61 mm  
 ↗ PDP - 25 x 6 mm





### GLASHOW • 97256

Bamboo and ABS speaker. This speaker has 3.0 Bluetooth transmission and a micro-USB port for charging. This speaker with built-in microphone has the following functions: answer calls, control volume and connect to mobile device's playlist. The speaker has 4Ω 3W and the battery has a capacity up to 400mAh. This speaker is supplied in a craft box.

∅60 x 52 mm

PDP - 25 x 20 mm



### PEREY • 97253

Rubber-finished ABS speaker with microphone, bluetooth transmission, TF card reader and 3W / 4Ω power. This speaker has autonomy up to 2 h and functions such as answer calls, control the volume and connect to the mobile device playlist. This product includes USB/micro USB cable for charging.

∅59 x 55 mm

PDP - 25 x 8 mm



- Microphone
- Call button
- Connection to mobile device's playlist
- Loading box



## DESCRY 97922

The DESCRY are metal and ABS headphones that are bold and distinctive. Their technical characteristics elevate it to a highly functional object. The DESCRY are supplied in a gift box.

▮ 31 x 78 x 38 mm | Charging box: 79 x 40 x 32 mm | Box: 128 x 110 x 58 mm  
 ↗ PDP - 25 x 10 mm



- Microphone
- Call button
- Connection to mobile device's playlist
- Loading box
- Water Resistant
- Includes a cable



## WIRETAP 97926

The WIRETAP are metal and ABS wireless headphones, with a bold and distinctive design. By allowing sound isolation and being waterproof these wireless headsets are distinguished by their quality and functionality. The WIRETAP are supplied in a gift box.

▮ 45 x 76 x 29 mm | Box: 126 x 124 x 49 mm  
 ↗ PDP - 25 x 10 mm



**GROOVY  
97928**

The GROOVY are comfortable and elegant headphones in imitation leather, metal and ABS, that are foldable and wireless. The GROOVY are a practical and an everyday product, that are supplied in a gift box.

200 x 160 x 73 mm | Box: 265 x 250 x 65 mm

PDP - 20 x 5 mm

- Foldable
- Microphone
- Volume control
- Call button
- Connection to mobile device's playlist
- Includes a cable



- Microphone
- Call button
- Volume control
- Connection to mobile device's playlist

**HEARKEEN  
97919**

The HEARKEEN are versatile headphones in ABS and silicone , perfect for different everyday moments. Due to their versatile design, they can be used in more professional environments, or for sports.

165 x 153 x 10 mm | Box: 201 x 220 x 40 mm  
PDP - 20 x 5 mm



**VIBRATION  
97923**

The VIBRATION are metal and ABS modern designed headphones that stand out for their metallic finished in the different details of the product. The VIBRATION are supplied in a gift box.

± 25 x 19 mm | Box: 88 x 97 x 45 mm

✂ LSR - 14 x 3 mm

- Microphone
- Call button
- Connection to mobile device's playlist
- Includes a cable



06



**KANDEL • 97912**

Wireless headset with 5.0 bluetooth transmission. These headsets have the following features: answer calls, control the volume and connect to the mobile device's playlist. These headsets come with their charging box with micro USB input.  
 ⚓ 71 x 55 x 28 mm | Headphone: 47 x 21 x 21 mm  
 🗡️ PDP - 25 x 20 mm

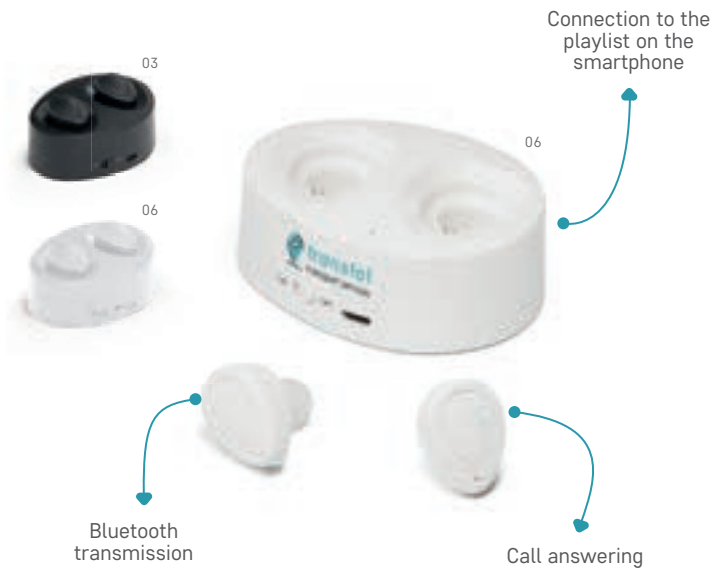

**CHARGAFF • 97210**

ABS wireless earbuds that allow bluetooth transmission and have autonomy up to 6 h. CHARGAFF headsets let you answer calls, control volume and connect to your mobile device's playlist. Includes USB/micro USB cable for charging and are supplied with charging base and gift box.  
 ⚓ Headphone: 27 x 20 x 28 mm | Base: 77 x 60 x 29 mm | Box: 83 x 83 x 40 mm  
 🗡️ PDP - 25 x 10 mm



**LINNAEUS • 97209**

PS wireless headset that allows bluetooth transmission and has autonomy up to 2 h. The headset allows you to answer calls and connect to the mobile device's playlist. Includes charging cable and is supplied in PS box.  
 ⚓ Headphone: 30 x 20 x 15 mm | Box: 60 x 60 x 20 mm  
 🗡️ PDP - 50 x 30 mm



### EDWIN • 97355



Adjustable, rubber-trimmed ABS headphones that allows bluetooth transmission. These headsets last up to 5 hours and allow you to answer calls, control volume and connect to the mobile device's playlist. They also allow pairing with 2 mobile devices simultaneously. Headphones include USB/micro USB cable for charging and are supplied in a gift box.

☞ 157 x 165 x 42 mm | Box: 161 x 200 x 55 mm  
 ✂ PDP - 10 x 30 mm



03



### HILLEMAN • 97356



Foldable ABS headphones with bluetooth transmission, TF card reader and autonomy up to 4h. Allows you to answer calls, control volume, connect to your mobile device playlist and FM radio. They include a USB/micro USB cable for charging and are supplied in a gift box (non-woven pouch included).

☞ Folded: 120 x 180 x 80 mm | Pouch: 200 x 250 mm |  
 Box: 127 x 171 x 90 mm  
 ✂ PDP - Ø35 mm



03



### BARON • 97365



Foldable and adjustable ABS headphones. They contain padded structure, bluetooth transmission and TF card reader. They have autonomy up to 4 hours and the following functions: answer calls, control the volume, connect to the mobile device playlist and to FM radio. They include a USB/micro USB cable for charging and are supplied in a gift box.

☞ Folded: 115 x 135 x 68 mm | Box: 150 x 150 x 70 mm  
 ✂ PDP - 15 x 30 mm



03



06



03



Magnetic earphones



**OTTO • 97913**

PC headset with 4.1 bluetooth transmission and control buttons. These headsets have the following features: answer calls, control the volume and connect to the mobile device's playlist. The battery has a capacity of 50mAh. The earphones come in an EVA pouch.

- ⊥ 80 x 65 x 32mm
- ⚡ PDP - 40 x 6 mm



**FIBONACCI • 97354**

ABS earphones with bluetooth transmission, up to 4h. Allows you to answer calls, control volume and connect to the mobile device playlist. They include a USB/micro USB cable for charging and are supplied in an EVA pouch with gift box.

- ⊥ Pouch: Ø85 x 35 mm | Box: 90 x 90 x 40 mm
- ⚡ PDP - Ø35 mm





Magnetic earphones



#### OLAH • 97914

PC headset with 4.2 bluetooth transmission and with control buttons. These headsets have the following features: answer calls, control the volume and connect to the mobile device's playlist. The battery has a capacity of 135mAh. The earphones come with a USB/micro USB cable for charging and are supplied in a non-woven pouch.

▮ 190 x 200 mm  
 ▮ PDP - 6 x 30 mm





**PINEL • 97359**

Retractable earphones, with 0.75m cable with 3.5mm stereo connection and supplied in a non-woven pouch.  
 ☿ 30 x 38 x 11 mm | Pouch: 60 x 105 mm  
 ⚡ PDP - Ø18 mm



**GERMAIN • 97358**

ABS earphones with 1.2m cable and 3.5mm stereo connection. These headsets are supplied in PP box.  
 ☿ Box: Ø55 x 20 mm  
 ⚡ SCR - Ø35 mm



**FARADAY • 97360**

Headset with 1.25m cable and 3.5mm stereo connection. These headsets are supplied in PS/ABS box.  
 ☿ Box: 60 x 64 x 16 mm  
 ⚡ PDP - 30 x 30 mm



Foldable  
headphones



### GOODALL • 97321

Foldable and adjustable ABS headphones. These headphones contain 1.45m cable with 3.5mm stereo connection and are supplied in a gift box.

📏 Folded: 100 x 155 x 50 mm | Box: 110 x 170 x 70 mm  
🔪 PDP - 18 x 50 mm



### VOLTA • 97331

ABS adjustable headphones that include 1.20m cable with 3.5 mm stereo connection.

📏 150 x 165 mm  
🔪 PDP - Ø35 mm



- Compatible with smartphones with wireless charging technology

**HORDE**  
**97921**

The HORDE is a wireless charger that combines metal and fabric into a perfect crossover that culminates in a sleek and sophisticated designed object. The HORDE is compatible with smartphones that have wireless charging technology, making it an everyday ally.

▮ 16 x 87 x 101 mm | Box: 169 x 154 x 34 mm  
🔗



- Compatible with smartphones with wireless charging technology

**MAGNET**  
**97920**

The MAGNET is a rugged wireless charger with a modern design in metal and acrylic. This charger has 10W charging power.

▮ 14 x 107 x 100 mm | Box: 157 x 179 x 34 mm  
🔗 LSR - 20 x 5 mm



- Lithium polymer battery
- Charges 2 devices simultaneously
- Universal compatibility
- LED indicator

## THINK 97916

The THINK is a versatile portable battery with an ABS and PC charging base that allows it to be simultaneously used as a wireless charger. The THINK is an object of bold design and given its technical characteristics can be used either for travel (as a portable battery) or as wireless charger. The battery is supplied in a gift box.

145 x 90 x 97 mm | Box: 212 x 195 x 58 mm

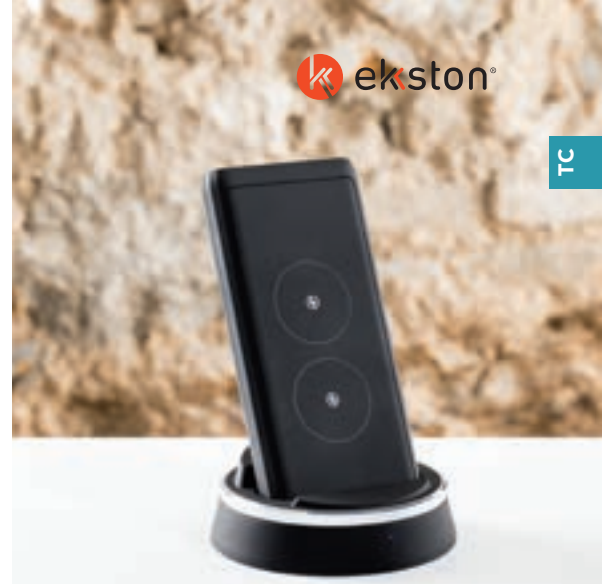

- Universal compatibility
- Lithium polymer battery
- LED indicator
- Charges 2 devices simultaneously

## TRENCHER 97925

The TRENCHER is a portable fabric-lined battery pack in a rubber-finished ABS housing that is distinguished by its modern yet elegant and intimate design. TRENCHER is supplied in a gift box.

140 x 70 x 16 mm | Box: 212 x 112 x 29 mm

SCR - 45 x 15 mm



- Charges 2 devices simultaneously
- LED indicator
- Universal compatibility
- Lithium polymer battery

## CROWD 97917

The CROWD is an ABS portable battery with a sleek and innovative design, designed to be an intuitive, everyday object. The portable battery is supplied in a gift box.

98 x 64 x 14 mm | Box: 148 x 144 x 34 mm

SCR - 40 x 10 mm





**KOHN • 97915**

Bamboo portable battery with capacity of 5.000 mAh. This battery has 5V/2A input/output, 2 micro-USB inputs and 1 USB output.

- ▮ 120 x 51 x 15 mm
- ▮ SCR - 80 x 30 mm



**FITCH • 97909**

Portable bamboo battery charger. Lithium battery. 5.000mAh capacity. Shelf life ≥ 500 cycles. Input / output 5V / 2A. Charging indicator, 1 micro USB port, 1 type C USB port and 1 USB port. Wireless output power, maximum 5W. Includes a USB / micro USB cable for charging. Compatible with smartphones with wireless charging technology. Comes in a gift box.

- ▮ 140 x 70 x 12mm
- ▮ SCR - 120 x 50 mm





60

**MOTT • 97911**

Bamboo and ABS office organizer with wireless charger with smartphone holder and USB hub with USB-C output. This organizer includes 5V and 1.5A input, 5V USB output and 5W charging capacity. Product supplied in craft box.

▮ 255 x 135 x 14 mm  
▮ LSR - 120 x 60 mm

**POWER • 97910**

Bamboo wireless charger with cable. The charger has 5V/2A inputs and has 5W charging power. This product is supplied in a craft box.

▮ 92 x 92 x 9 mm  
▮ SCR - 70 x 70 mm

60





06

**STEVEN'S** • 97154

USB ABS charging station with 5 5V/4A outputs.

⊥ 65 x 110 x 80 mm  
 ↗ PDP - 25 x 50 mm

## COUPLE WITH FAST CHARGERS

97906 + 97908



06

**REDI** • 97362

ABS USB adapter with 2 5V/1-2.1A output.

⊥ 62 x 42 x 23 mm  
 ↗ PDP - 30 x 30 mm



06



03

**HOUSTON** • 97160

ABS Qualcomm 3.0 adapter with 2.0 USB input.  
 The charger has 100V-250V, 50-60Hz, 0.35A  
 AC input and DC5V/3.1A, 9V/2.0A, 12V/1.5A 18W  
 output voltage.

⊥ 42 x 25 x 85 mm  
 ↗ PDP - Ø40 mm



06

**WOESE** • 97361

ABS USB adapter with 5V/1A output.

⊥ 48 x 35 x 14 mm  
 ↗ PDP - 35 x 15 mm



# COUPLE WITH ADAPTORS

97160 + 97362



03

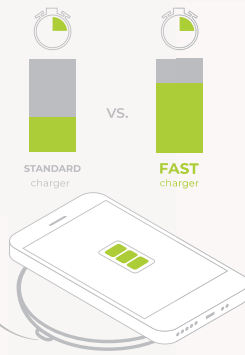

## BURNELL • 97908

Backlit ABS wireless charger with rubber finish. This charger has micro USB cable that allows quick charging. The charger has 5V/2A and 9V/1.67A inputs and has 10W charging power.

⊥ Ø99 x 9 mm | Cable: 1000 mm  
 ↗ LSR - Ø30 mm



06



## HIPERLINK • 97906

ABS and silicone wireless charger with USB cable for fast charging. The charger has 5V/2A and 9V/1.67A inputs and has charging power of 5W, 7.5W or 10W. This charger is supplied in a gift box.

⊥ Ø69 x 10 mm  
 ↗ PDP - Ø40 mm



06

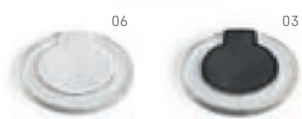

06

03



## COUSTEAU • 97346

ABS wireless charger that allows charging the device by induction. It has 5V/2A input and 5W charging power. Includes USB/micro USB cable for charging. This product is compatible with smartphones with wireless charging technology.

⊥ Ø100 x 10 mm  
 ↗ PDP - 25 x 15 mm



03



06

## CAROLINE • 97903

Wireless charger and USB 2.0 hub in ABS. This product allows to charge the device by induction, has 5V/2A input, 5V/0.5-1A output, 2 USB ports and 5W charging power. Includes USB/micro USB cable for charging and is compatible with smartphones with wireless charging technology.

⊥ 90 x 90 x 10 mm  
 ↗ PDP - 50 x 30 mm



27  
03



06



**NOBEL • 97351**

Aluminum portable battery with lithium battery. This battery has a capacity of 7,200 mAh, lifetime over 500 cycles contains 5V/1A input, 5V/1-2.1A output and 2 USB ports. Includes USB/micro USB cable to charge the battery and is supplied in a gift box.

▮ 150 x 74 x 12 mm | Box: 165 x 80 x 20 mm  
 ↗ SCR - 120 x 50 mm



**FUSION • 45328**

Portable battery with capacity up to 4,000 mAh and speaker with bluetooth transmission. This battery is suitable for charging smartphones (Android and iOS) and tablets and has the following technical specifications: 3W power, with 2.1 EDR bluetooth transmission up to 10m, 4,000 mAh battery capacity, 5-6 hours charging time, 30-hour autonomy, built-in conference call microphone, play/stop button directly on speaker. This promotional product is compatible with all devices that support Bluetooth streaming connectivity as well as the audio cable. Includes USB cable and Jack/Jack.

▮ 144 x 26 x 80 mm  
 ↗ PDP - 50 x 15 mm



27



24  
27  
03



**FERMAT • 97343**

Portable battery. Aluminium. Lithium battery. Power: 7.200 mAh. Lifespan ≥ 500 cycles. With 5V/1A input/output. Includes USB/micro USB charging cable. Supplied in gift box.

▮ 90 x 77 x 22 mm | Box: 110 x 85 x 25 mm  
 ↗ LSR - 70 x 50 mm



**MARCET • 97344**

Aluminum portable battery with lithium battery, capacity of 4,000 mAh and lifetime over 500 cycles. This battery has 5V/1A input/output, includes USB/micro USB cable to charge the battery and is supplied in a gift box.

▮ 110 x 68 x 10 mm | Box: 115 x 70 x 25 mm  
 ↗ LSR - 90 x 50 mm



# PORTABLE INDUCTION BATTERY

TC



## NATTA • 97904

Portable battery in ABS and rubber finishing with inductive charging. Lithium battery. Capacity: 10,000 mAh. Life time  $\geq$  500 cycles. With 5V 2.1A input/output and 5W charging power. With charging indicator and USB, micro USB and Type C USB ports. Includes USB/micro USB cable to charge the battery. Compatible with smartphones with wireless charging technology. Supplied in gift box.

☰ 135 x 75 x 20 mm | Box: 150 x 95 x 25 mm  
 ✂ DUV - 50 x 25 mm



Textured finish effect



Charging indicator

LED

## RAMAN • 97905



Portable ABS battery with LED, 16,000 mAh capacity lithium battery, over 1,000 cycle life, with 5V/2.1A input, 5V/1-2.1A output, charging indicator, 2 USB ports and 1 port micro USB. This battery has protection against overcharge, short circuit and overheat. Includes USB / micro USB cable to charge the battery and is supplied in a gift box.

☰ 156 x 80 x 23 mm | Box: 175 x 100 x 30 mm  
 ✂ SCR - 100 x 55 mm



03



**HEVESY • 97323**

Portable aluminum and lithium battery. HEVESY has a capacity of 2,200 mAh and a lifetime of over 500 cycles. This battery has 5V/1A input/output and includes USB/micro USB cable to charge the battery.  
 ⚓ 95 x 23 x 22 mm  
 ⚓ LSR - 80 x 13 mm



**GIBBS • 97311**

ABS portable battery and lithium battery. It has a capacity of 2,000 mAh and a lifetime of over 500 cycles. This battery has 5V/1A input/output and includes USB/micro USB cable to charge the battery.  
 ⚓ 96 x 22 x 24 mm  
 ⚓ PDP - 50 x 15 mm

# TECHNICAL SPECIFICATIONS

| <b>Ref.</b>                             | 97311  | 97323           | 97327            | 97391            | 97343           | 97344            | 97351            | 97904            | 97915            | 97909            | 45328            | 97905            |
|---|--|-----------------|------------------|------------------|-----------------|------------------|------------------|------------------|------------------|------------------|------------------|------------------|
| <b>Dimensions:</b>                      | 96 x 22 x 24 mm  | 95 x 23 x 22 mm | 143 x 77 x 16 mm | 112 x 42 x 25 mm | 90 x 77 x 22 mm | 110 x 68 x 10 mm | 150 x 74 x 12 mm | 135 x 75 x 20 mm | 120 x 51 x 15 mm | 140 x 70 x 12 mm | 144 x 26 x 80 mm | 156 x 80 x 23 mm |
| <b>Material:</b>                        | ABS  | Aluminium       | ABS              | ABS              | Aluminium       | Aluminium        | Aluminium        | ABS              | Bamboo           | Bamboo           | ABS              | ABS              |
| <b>Available colours:</b>               | 03, 05, 06, 14   | 03, 04, 05, 44  | 03               | 07, 72           | 44              | 03, 04, 44       | 03, 44           | 07               | 60               | 60               | 06               | 03               |
| <b>Capacity:</b>                        | 2.000 mAh  | 2.200 mAh       | 1.800 mAh        | 2.000 mAh        | 7.200 mAh       | 4.000 mAh        | 7.200 mAh        | 10.000 mAh       | 5.000 mAh        | 5.000 mAh        | 4.000 mAh        | 16.000 mAh       |
| <b>Battery type:</b>                    | Li-ion   | Li-ion          | Li-polymer       | Li-ion           | Li-polymer      | Li-polymer       | Li-polymer       | Li-polymer       | Li-polymer       | Li-polymer       | Li-polymer       | Li-ion           |
| <b>Power:</b>                           | Input: 5V/1A<br>Output: 5V/1A, 5V/1-2.1A   |                 |                  |                  |                 |                  |                  |                  |                  |                  |                  |                  |
| <b>No. Cycles charging/discharging:</b> | ≥500 cycles  |                 |                  |                  |                 |                  |                  |                  |                  |                  |                  | ≥ 1.000 cycles   |
| <b>Compatibility:</b>                   | These portable batteries are compatible with smartphones, tablets, cameras, consoles, MP3/MP4, and other electrical equipment. |                 |                  |                  |                 |                  |                  |                  |                  |                  |                  |                  |
| <b>Certification and security:</b>      | All models include overheating security system and comply with EU RoHS Directive.  |                 |                  |                  |                 |                  |                  |                  |                  |                  |                  |                  |



23



13



### OMAR • 97391

ABS portable battery and lithium battery. This battery has a capacity of 2,000 mAh and a lifetime of over 500 cycles. It has 5V/1A input/output and includes USB/micro USB cable to charge the battery. This battery is supplied in a gift box.

☒ 112 x 42 x 25 mm | Box: 173 x 96 x 30 mm

🔪 SCR - 60 x 10 mm



06

### CHARGI • 97326

ABS battery set and USB adapters. This set includes a portable battery with lithium battery and a USB/micro USB cable. The battery has a capacity of 2,000 mAh and a lifetime of over 500 cycles. Includes car and power adapters with 5V/1A output and is supplied in an EVA pouch.

☒ Pouch: 112 x 80 x 45 mm

🔪 PDP - 35 x 15 mm



03



LED

### SEABORG • 97327

Portable ABS battery with rubber finish and lithium battery. The battery includes solar panel and LED. It has a capacity of 1,800 mAh and a lifetime of over 500 cycles. It has 5V/1A input/output and 2 USB ports. Includes USB/micro USB cable to charge the battery and is supplied in a gift box.

☒ 143 x 77 x 16 mm | Box: 165 x 80 x 20 mm

🔪 SCR - 50 x 20 mm



**JANNES • 97318**

USB 2.0 hub with 4 ports.  
 ⏏ 52 x 41 x 12 mm  
 ⚡ PDP - 40 x 20 mm



**GARDNER • 97357**

USB 2.0 hub in ABS, with 4 ports.  
 ⏏ Ø52 x 18 mm  
 ⚡ PDP - Ø35 mm



**LEGOLAS • 45194**



4-port USB 2.0 hub that includes USB/micro USB cable.  
 ⏏ 119 x 30 x 22 mm  
 ⚡ PDP - 55 x 12 mm



**CASE I • 45293**

Multipurpose EVA bag for portable battery and other tech accessories.  
 ⏏ 116 x 42 x 55 mm  
 ⚡ PDP - 50 x 20 mm



### NOETHER • 97157

Made for  
 iPhone | iPad | iPod

3-in-1 USB cable that is suitable for charging mobile devices. Features a micro USB connector and Lightning® (MFI certified) and Type C USB adapters. This product is supplied in an EVA pouch.

⌵ Cable: 1020 mm | Pouch: Ø75 x 36 mm  
 ⚡ SCR - Ø30 mm



### EMMY • 97153

3 in 1 USB cable in ABS and PVC. This cable is suitable for charging mobile devices: it has a Type C USB connector and a 2 in 1 connector. It is compatible with micro USB inputs and iOS operating system. This product is supplied in a PP box.

⌵ Box: Ø55 x 20 mm  
 ⚡ PDP - Ø35 mm



### RIEMANN • 97152

USB cable with 2-in-1 connector. This ABS and PVC product is suitable for charging mobile devices and is compatible with micro USB ports and iOS operating system. This customisable product contains a keyring.

⌵ 12 x 50 x 10 mm  
 ⚡ PDP - 8 x 15 mm



50



**VENTER • 97535**

4GB USB stick in bamboo.  
 60 x 19 x 10 mm | Box: 90 x 40 x 22 mm  
 SCR - 35 x 14 mm



06



**WALLACE • 97536**

UDP memory 4GB card in ABS.  
 86 x 54 x 3 mm | Box: 103 x 72 x 10 mm  
 SCR - 40 x 30 mm



27



02



03

27

06

14

24

05

02

28

19

**CLAUDIUS • 97548 / 97549 / 97433**

USB flash drive.  
 97548: capacity 4GB. Colours: 02, 03, 04, 05, 06, 19, 24, 27 and 28  
 97549: capacity 8GB. Colours: 02, 03, 04, 05, 06, 19, 24, 27 and 28  
 97433: capacity 16GB. Colours: 03, 05, 14 and 27  
 56 x 19 x 10 mm | Box: 86 x 45 x 20 mm  
 LSR - 25 x 13 mm





### BOYLE • 97567

Mini 4GB UDP memory with metal clip and supplied in PP box.

∓ 55 x 17 x 8 mm | Box: 68 x 25 x 15 mm

↗ LSR - 35 x 12 mm



### SIMON • 97566

Mini 4GB UDP memory in aluminum and supplied in PP box.

∓ 33 x 12 x 6 mm | Box: 68 x 25 x 15 mm

↗ LSR - 25 x 9 mm



### SAVERY • 97524

ABS ball pen with metal clip and UDP memory. The memory has a capacity of 4GB. The product is supplied with a gift box (disassembled).

∓ Ø12 x 144 mm | Case: 150 x 15 x 19 mm

↗ PDP - 7 x 50 mm



### BRAGG • 97568

Mini 4GB UDP memory in imitation leather clip and supplied in PP box.

∓ 100 x 26 x 11 mm | Box: 115 x 60 x 25 mm

↗ PDP - 25 x 12 mm





### CRICK • 97398

2.4G wireless mouse in ABS and rubber finishing.  
This product includes 2 AAA batteries.

▮ 65 x 105 x 20 mm  
✂ PDP - 8 x 25 mm



### BLACKWELL • 97304

2.4G wireless ABS mouse that includes 2 AAA batteries  
and is supplied in a clear box.

▮ 57 x 113 x 20 mm | Box: 64 x 120 x 36 mm  
✂ PDP - 20 x 30 mm





## PROTECT YOUR PRIVACY WITH OUR WEBCAM PROTECTOR

TC



### HIDE • 57951

PP webcam protector with sliding cover and sticker on the back. This protector has universal format and is suitable for smartphone, tablet and laptop.

▮ 43 x 13 mm | Closed: 32 x 13 mm  
 ⚡ PDP - 20 x 8 mm



### SKINNER • 97369

Optical mouse with 0.70 m retractable cable and USB connection.

▮ 60 x 103 x 34 mm  
 ⚡ PDP - 10 x 25 mm



### LED LUMEN • 45314

Silicone portable lamp with 4 LEDs, touch switch and USB connection.

▮ 16 x 185 x 7 mm  
 ⚡ PDP - 13 x 9 mm

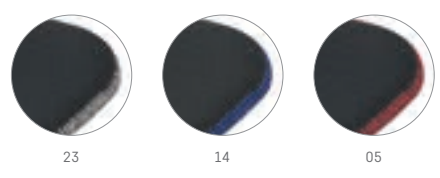

**THOMAS • 92314**

Tablet PC pouch. High density soft shell. For 10.1" tablet.  
 197 x 258 mm  
 TRS - 140 x 140 mm



**CARLET • 72280**

Imitation leather car organizer with tablet (up to 10.5") stand and elastic to hang on the front seat.  
 220 x 280 x 25 mm  
 SCR - 70 x 100 mm



**TABLETO • 71989**

Leather imitation tablet (up to 10.5") case with notepad included.  
 210 x 250 x 25 mm  
 SCR - 60 x 100 mm



14"

**SEATTLE** • 92290

Laptop bag. High density soft shell. For laptop up to 14".  
With front pocket.

▮ 370 x 280 x 30 mm

✂ TRS - 200 x 100 mm



03



03

14"

**AVERY** • 92352

Soft shell pouch for laptop up to 14".

▮ 355 x 280 x 30 mm

✂ TRS - 260 x 190 mm



04



### WAKSMAN • 93573

Metal memo clip with mobile phone or business card holder.

▮ 40 x 130 x 40 mm  
 ⚡ LSR - 20 x 25 mm



### ENFIELD • 97765

8-digit dual-power calculator that includes 1 AG10 battery.

▮ 151 x 112 x 28 mm  
 ⚡ PDP - 40 x 15 mm



### HENRY • 97060

Digital clock with calendar including 1 LR44 battery.

▮ 105 x 30 x 27 mm  
 ⚡ PDP - 40 x 15 mm



### HOME • 42092

Plastic table clock with magnet and note holder. This clock has the following functions: 12 or 24 mode, alarm, timer and thermometer. Includes one battery.

▮ 100 x 107 x 32 mm  
 ⚡ PDP - 45 x 15 mm



### ILSE • 97084

Desk station with the following functions: 12- or 24-hour clock, alarm, calendar, thermometer, hygrometer and colour display. Includes 2 AAA batteries.

⊥ 80 x 140 x 39 mm  
 ↗ STI - 30 x 50 mm



### LED DARWIN • 97390

MDF clock. This clock contains calendar, alarm, thermometer and includes 4 AAA batteries, 1 CR2032 battery, USB cable and is supplied in a gift box.

⊥ 150 x 70 x 44 mm | Box: 170 x 92 x 54 mm  
 ↗ PDP - 50 x 25 mm



### EDEM • 97065

Acrylic pen holder with calendar, alarm and thermometer. This pen holder includes 1 CR2025 battery.

⊥ 95 x 118 x 50 mm  
 ↗ PDP - 15 x 50 mm



### DENE • 97070

Aluminum desk station with LCD screen. This station has calendar, alarm and weather information and forecast. Includes 2 AAA batteries.

⊥ 130 x 130 x 19 mm  
 ↗ SCR - 80 x 18 mm

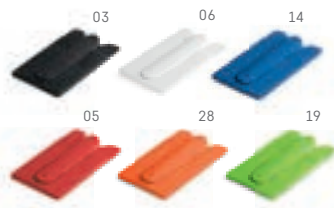

**CARVER • 93321**

Silicone smartphone card holder with sticker on the back and smartphone holder.  
 57 x 96 x 5 mm  
 SCR - 10 x 40 mm

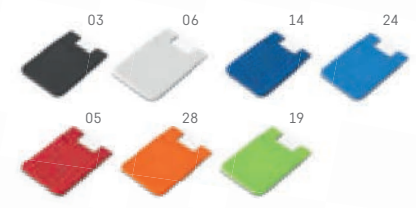

**SHELLEY • 93320**

Silicone smartphone card holder with sticker on the back.  
 57 x 87 x 3 mm  
 SCR - 30 x 40 mm



**NICOLAUS • 94446**

Silicone card holder with lanyard and smartphone holder.  
 Card holder: 57 x 86 x 4 mm | Lanyard: 420 mm  
 SCR - 32 x 40 mm



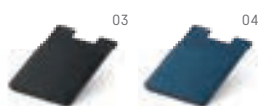

### **BLOCK • 93334**

PU card holder with RFID notepading technology. This card holder for 1 card has adhesive tape on the back allowing it to be placed on a surface, such as the mobile phone.

▮ 92 x 62 x 3 mm  
 ↗ SCR - 45 x 45 mm



### **FRANCK • 93331**

PU card holder with RFID lock. This card holder has capacity for 2 cards, has an adjustable PU strap and adhesive tape on the back allowing it to be attached to a surface.

▮ 102 x 63 x 3 mm  
 ↗ PDP - 40 x 10 mm

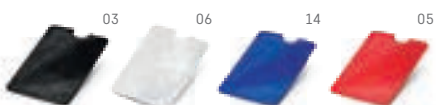

### **MEITNER • 93333**

Aluminum card holder with RFID notepading technology. This card holder holds up to one card.

▮ 92 x 63 mm  
 ↗ SCR - 45 x 45 mm



### **MULLER • 93332**

Aluminum card holder with RFID notepading technology and polyester elastic strap. This card holder has a matte finish and has capacity for 12 cards.

▮ 90 x 58 mm  
 ↗ LSR - 50 x 20 mm



**THOM • 99016**

Synthetic mesh gloves with touch tips.  
 Size: 8  
 TRS - 50 x 40 mm



**OCULARS • 45315**

Adjustable virtual reality glasses supplied in case.  
 Case: 130 x 24 x 70 mm  
 DUV - 130 x 67 mm



**Inox PYTHAGORAS • 97086**

EVA and stainless steel monopod extendable stick. Includes a 3.5mm stereo connecting cable and shutter button. Extendable stick up to 615 mm.  
 45 x 140 x 30 mm  
 LSR - 10 x 30 mm



**SELFIE • 45255**

Extendable metal selfie stick. Includes a 3.5mm stereo connecting cable and shutter button.  
 51 x 28 x 328 mm  
 PDP - 50 x 10 mm





**TOBY • 45331**

Silicone mobile phone holder with cable organizer.  
 39 x 37 x 25 mm  
 DOM - 33 x 19 mm



**GEORGES • 97150**

ABS smartphone ring holder with sticker on the back.  
 35 x 40 x 6 mm  
 PDP - 6 x 25 mm



**HILBERT • 97387**

3-in-1 ABS and Aluminum Universal Mini Lens Set The set includes: 1 clip, 1 macro lens (10x), 1 angle lens (0.67x), 1 fisheye lens (180°), 2 lens caps and 1 velvet bag. This product is ideal for smartphones and tablets and is supplied in a box.  
 137 x 95 x 25 mm  
 PDP - 15 x 5 mm



**LAVOISIER • 97342**

ABS bluetooth locator with keyring and up to 20m range and geolocation. Includes 1 CR2032 battery and is compatible with Android and iOS. Supplied in gift box.  
 37 x 37 x 7 mm | Box: 50 x 50 x 16 mm  
 PDP - 25 x 25 mm



**PLANCK • 97156**

Aluminum car phone holder. This product includes a magnetic metal piece with 360° swivel frame, allowing to adapt the position of the mobile phone. Contains a sticky surface to place on the phone.

∓ Ø35 x 44 mm  
 ↗ PDP - 25 x 25 mm



**EULER • 97338**

ABS mobile phone holder.

∓ 50 x 97 x 28 mm  
 ↗ PDP - 15 x 15 mm



**WALLIS • 97366**

ABS car phone holder.

∓ 40 x 78 x 25 mm  
 ↗ PDP - 7 x 30 mm



**NOSLIP • 71071**

Non-slip PU mat.

∓ 144 x 89 mm  
 ↗ DGL - 48 x 25 mm





**PAULING • 97316**

ABS car USB adapter with 2 5V/1-2.1A outputs.

⊥ 37 x 80 x 26 mm

↗ PDP - 8 x 20 mm



**WATT • 97155**

USB car adapter in ABS and aluminum with 2 5V / 1-2.1A outputs.

⊥ 31 x 31 x 63 mm

↗ PDP - 17 x 8 mm



**PLUG • 97120**

USB Car adapter with 2 5V/1A and 5V/2.1A outputs and 12-24V input voltage. This product is suitable for charging mobile phones and GPS devices.

⊥ 39 x 50 x 72 mm

↗ STI - 15 x 20 mm



**CARTECH • 45326**

keyring with USB car adapter, with 5V/1A output and 12-24V input. Suitable for charging smartphones.

⊥ 24 x 16 x 67 mm

↗ PDP - 33 x 13 mm



**CHARGE • 45192**

USB car adapter with 5V/1A output and 12-24V voltage input. This product is suitable for charging mobile phones.

⊥ Ø25 x 45 mm

↗ PDP - 12 x 3 mm





**HOOKE • 97367**

Mobile phone holder in ABS and TPR.  
 Closed: 89 x 30 x 9 mm  
 SCR - 45 x 25 mm



**UREY • 97307**

Touch tip with LCD screen cleaner.  
 62 x 30 x 12 mm  
 PDP - 35 x 12 mm



**ALVAREZ • 97320**

ABS touch tip.  
 27 x 62 x 2 mm  
 PDP - 11 x 25 mm





**SIGN I**  
**81206**

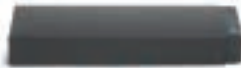

The SIGN I is a sleek metal ball pen with matte black finishing and stainless steel clip. The SIGN I is a sophisticated, minimalist design object that has black Dokumental Ink® refill. It is supplied in a gift box.

∅10 x 135 mm | Box: 53 x 187 x 28 mm  
 LSR - 40 x 5 mm



**SIGN II**  
**81207**

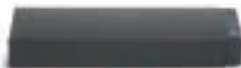

The SIGN II is a sleek metal roller with matte black finishing and stainless steel clip. The SIGN II has black Dokumental Ink® refill. It is supplied in a gift box.

∅10 x 135 mm | Box: 53 x 173 x 28 mm  
 LSR - 40 x 5 mm





**NEO**  
**81001**



NEO is an avant-garde, ergonomic aluminum ball pen with twist mechanism that is designed for professionals who use a notepad and a tablet as their office. The silicone touch tip enhances its usefulness and the matt/glossy lacquered body adds elegance. The ball pen has a cross-type metal refill and black Dokumental® ink. This product comes in a cushioned gift box.

∅10 x 138 mm | Case: 175 x 41 x 20 mm  
PDP - 6 x 45 mm



**HOOK MATTE**  
**81003**

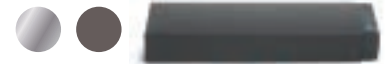

The HOOK Matte ball pen is elegant and sophisticated, that hardly goes unnoticed. It is a bronze ball pen with twist mechanism, bright chrome plating and iron spring clip, which gives it strength and flexibility. The shiny chrome-plated tip and double-finished body (platinum-plated interior and matt lacquered exterior) enhance not only the elegant design but the quality of the HOOK Matte. It has a G2 metal refill with blue Dokumental® ink. The Hook Matte is supplied in a gift box.

∅11 x 142 mm | Case: 175 x 41 x 20 mm  
PDP - 7 x 40 mm

**STAIN**

**81208**

The STAIN is a textured roller and stainless steel lid. The STAIN roller is inspired by geometric lines, has a black Dokumental Ink® refill. It is supplied in a gift box.

∅10 x 135 mm | Box: 53 x 187 x 28 mm  
 LSR - 40 x 4 mm

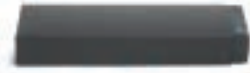
**AUTOGRAPH**

**81205**

The AUTOGRAPH is a sophisticated ball pen and roller set. The Roller is matt black metal and stainless steel lid and the Ball pen is matt black metal and stainless steel clip. In this minimalist and exquisite set the ball pen and roller have black Dokumental Ink® refill. It is supplied in a gift box.

∅10 x 135 mm | Box: 73 x 173 x 28 mm  
 LSR - 40 x 5 mm



**BAHIA • 91820**

Bamboo ball pen with metal clip.  
Supplied in bamboo case.

∅ 11 x 140 mm | Box: 170 x 40 x 25 mm

LSR - 6 x 35 mm

**LUANDA • 91819**



Bamboo roller and ball pen set. The roller and ball pen have a metal clip. Set supplied in bamboo case.

∅ 12 x 140 mm | Box: 171 x 57 x 25 mm

LSR - 5 x 35 mm







 **CORK • 81401**

 Cork and metal ball pen inspired in the cork oak. Its natural feel allows it to be both distinctive and sturdy, without detracting from its innovative design. This ball pen is supplied in a gift case with cork detail.





∅ 11 x 137 mm | Case: 180 x 56 x 30 mm  
LSR - 6 x 40 mm





 **GREENY • 81162**  
 Bamboo ball pen and 0.7 graphite mechanical pencil set. Supplied in a cardboard gift box.  
  $\pm$  Ø11 x 138 mm | Case: 171 x 53 x 23 mm  
 SCR - 20 x 60 mm





 **HERA • 81163**  
 Simple and elegant bamboo ball pen.  
 $\pm$  Ø11 x 138 mm  
 PDP - 7 x 50 mm



 **PATI • 81153**  
 Bamboo ball pen with non-slip grip, plastic clip and plastic tip.  
 $\pm$  Ø11 x 142 mm  
 PDP - 7 x 50 mm



 **BAMBU • 91378**  
 Bamboo ball pen with plastic clip.  
 $\pm$  Ø11 x 142 mm  
 PDP - 7 x 50 mm



### LAKE • 91339



Bamboo ball pen with metal clip. This ball pen is supplied with a cardboard pouch.

∅ 11 x 137 mm | Pouch: 155 x 40 mm

✂ PDP - 7 x 40 mm



60



### BACH • 91335



Bamboo ball pen with metal clip and non-slip grip. Supplied with cardboard pouch.

∅ 12 x 140 mm | Pouch: 155 x 40 mm

✂ PDP - 7 x 50 mm



03



### NATURA • 91647



Cork and aluminum ball pen. Supplied with cardboard gift pouch.

∅ 9 x 139 mm | Pouch: 155 x 40 mm

✂ SCR - 10 x 100 mm

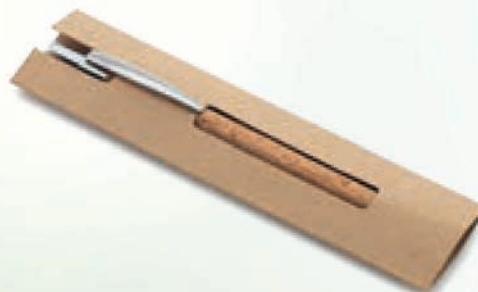

60

# LESS PLASTIC, MORE ENVIRONMENTALLY FRIENDLY



WR



**CAMILA • 81168**



Wheat straw fiber and ABS ballpoint with clip and blue ink.

∅10 x 141 mm

PDP - 6 x 60 mm



 **TERRY • 81204**

 Wheat straw fiber and ABS ballpoint with clip.  
 ∅ 12 x 140 mm  
 PDP - 7 x 40 mm



COUPLE YOUR DEVIN BALLPOINT PEN  
 WITH YOUR ROCK NOTEPAD (PG. 59)



 **DEVIN • 81203**

 Wheat straw fiber and ABS ballpoint  
 with clip and black ink.  
 ∅ 8 x 126 mm  
 PDP - 5 x 45 mm





 **HYDRA • 91482**

-  Ball pen in recycled PET material.  
 ∓ Ø11 x 139 mm  
 ↗ PDP - 7 x 50 mm



 **WOODY • 91219**

-  Wooden ball pen with lid included.  
 ∓ Ø14 x 122 mm  
 ↗ PDP - 6 x 25 mm



 **BIO • 91291**

-  Wooden ball pen with plastic cap.  
 ∓ Ø10 x 150 mm  
 ↗ PDP - 6 x 60 mm



 **RECICLA • 91290**

-  Craft paper ball pen with interior made of recycled newspaper.  
 ∓ Ø6 x 145 mm  
 ↗ PDP - 5 x 60 mm

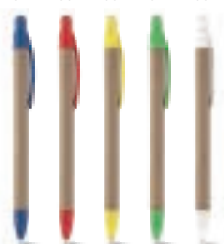

04 05 08 09 06

**REMI • 91628**

Craft paper ball pen with clip and tip in plastic.

∅10 x 138 mm

PDP - 6 x 50 mm

**PAPYRUS • 91621**

Ball pen in craft paper and ABS, with touch tip.

∅10 x 115 mm

PDP - 6 x 50 mm

04 05 09 19

**NAIROBI • 91292**

Craft paper ball pen with wooden clip.

∅9 x 140 mm

PDP - 6 x 50 mm

**LEAF • 91846**

Craft paper ball pen and pencil set. Both products include plastic clip and tip. The mechanical pencil is 0.5mm. Products are supplied in a cardboard pouch.

∅10 x 138 mm | Pouch: 175 x 55 mm

PDP - 6 x 50 mm





 **CHESS • 91835**

Metal and carbon fiber roller and ball pen set. Supplied in a padded imitation leather case.

∓ Ø13 x 139 mm | Box: 195 x 100 x 47 mm

✂ LSR - 6 x 35 mm



 **WARHOL • 91836**

 Metal roller and ball pen set. The roller has black ink and the ball pen has blue ink. The set is supplied in a padded gift case.

∓ Ø13 x 135 mm | Box: 185 x 75 x 31 mm

✂ PDP - 6 x 27 mm



 **TARTAN • 91442**

 Set that includes a ball pen and a metal roller. The roller has black ink and the ball pen has blue ink. Supplied in a padded gift box.

∓ Ø10 x 135 mm | Case: 185 x 75 x 31 mm

✂ LSR - 5 x 45 mm

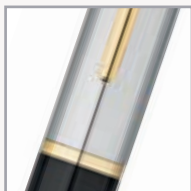

18k gold plated



17



### LOUVRE • 91489

Elegant metal ball pen with 18-carat gold-plated elements highlighting its exquisite finishes. LOUVRE is supplied in a padded gift box.

∅ 12 x 139 mm | Case: 179 x 56 x 30 mm  
 LSR - 6 x 35 mm



18k gold plated



17



### VERSAILLES • 81146

Stylish metal roller and ball pen set. Its 18-carat gold-plated elements make this set exquisite. Supplied in a padded gift case.

∅ 12 x 136 mm | Case: 185 x 75 x 31 mm  
 PDP - 6 x 30 mm



03



**IMPERIO • 81194**

Metal ball pen and roller set provided in elegant cushioned gift box.

Ball pen: Ø13 x 137 mm | Roller: Ø13 x 137 mm | Box: 180 x 30 x 56 mm  
 LSR - 6 x 40 mm



03



**BENTON • 91842**

Metal roller and ball pen set. Supplied in a padded gift case.

Ø13 x 136 mm | Case: 185 x 75 x 31 mm  
 LSR - 5 x 30 mm



07



**EDMOND • 81171**

Metal ball pen and roller set supplied in cushioned gift box.

Ball pen: Ø12 x 139 mm | Roller: Ø12 x 139 mm | Box: 192 x 34 x 85 mm  
 LSR - 6 x 40 mm



07



**ORLANDO • 81193**

Metal ball pen and roller set supplied in gift box with magnet closure.

Ball pen: Ø13 x 136 mm | Roller: Ø13 x 135 mm | Box 192 x 34 x 85 mm  
 LSR - 5 x 25 mm



**ROYAL • 81209**

Metal ball pen and roller set supplied in cushioned gift box.

☒ Box: 192 x 34 x 85 mm  
 ✂ DGL - 90 x 50 mm



**MOON • 91439**

Elegant roller in metal and imitation leather. Supplied in a padded gift case.

☒ Ø13 x 141 mm | Case: 180 x 78 x 35 mm  
 ✂ PDP - 7 x 30 mm



**EZEKIEL SET • 81210**

Metal ball pen and roller set supplied in cushioned gift box.

☒ Ø11 x 140 | Box: 180 x 57 x 25 mm  
 ✂ LSR - 6 x 40 mm



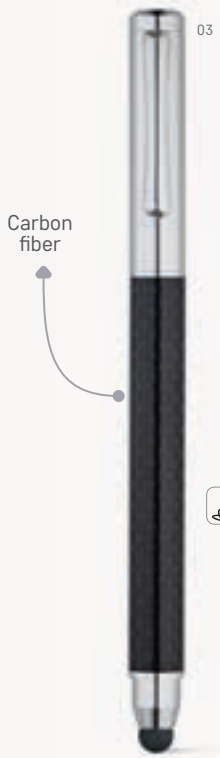

 **RUBIC • 91845**

Roller pen in metal and carbon fiber. The roller has a touch tip and comes in a padded gift case.  
 ∓ Ø11 x 138 mm | Case: 179 x 55 x 30 mm  
 ✂ LSR - 5 x 40 mm

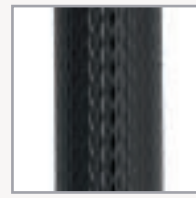

 **DURBAN • 81145**

Metal roller pen. Supplied in a padded gift case.  
 ∓ Ø12 x 138 mm | Case: 175 x 55 x 25 mm  
 ✂ LSR - 5 x 35 mm



 **EZEKIEL • 81195**

Metal ball pen supplied in a craft paper case.  
 ∓ Ø11 x 139 | Box: 180 x 43 x 22 mm  
 ✂ LSR - 6 x 40 mm



 **EZEKIEL ROLLER • 81196**

Metal roller supplied in craft paper case.  
 ∓ Ø11 x 140 | Box: 180 x 43 x 22 mm  
 ✂ PDP - 7 x 40 mm

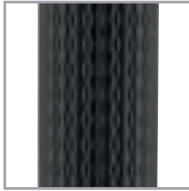

**BLAZON • 81147**

Metal roller pen. Supplied in a padded gift case.

∅ 11 x 137 mm | Case: 179 x 55 x 30 mm  
PDP - 6 x 35 mm

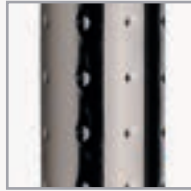

**UWE • 81200**

Metal roller pen in paper gift box with magnetic buckle, blue refill.

180 x 25 x 45 mm | Case: 193 x 62 x 34  
PDP - 7 x 40 mm



**SILVERIO • 81170**

Metal ball pen supplied in gift box.

∅ 10 x 131 mm | Box: 182 x 22 x 42 mm  
LSR - 6 x 45 mm





### CALIOPE SET • 81199

Metal ball pen and roller set supplied in cushioned gift box.

☿ Ball pen: Ø10 x 133 mm | Roller: Ø10 x 137 mm  
 | Box: 180 x 57 x 25 mm  
 ✂ LSR - 6 x 45 mm



### CANNES • 91833

Elegant set with metal ball pen and roller with touch tip. This set is supplied in a padded gift case.

☿ Ø10 x 145 mm | Box: 170 x 70 x 30 mm  
 ✂ LSR - 5 x 40 mm



### DOURO • 91816

Metal roller and ball pen set. Supplied in a padded gift case.

☿ Ø12 x 132 mm | Box: 170 x 70 x 30 mm  
 ✂ PDP - 5 x 30 mm



**MONTREAL • 91348**

Metal ball pen. Supplied in padded gift box.  
 ∅ 11 x 138 mm | Case: 170 x 50 x 28 mm  
 LSR - 6 x 40 mm

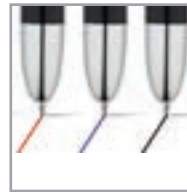

3 different colours



Automatic pencil



**SKETCH • 91843**

Ball pen and mechanical pencil 4 in 1. Metal ball pen and mechanical pencil with different writing possibilities: pencil, writing in red, blue and black. Product supplied in padded gift box.  
 ∅ 10 x 132 mm | Case: 150 x 43 x 24 mm  
 PDP - 6 x 50 mm



**HALEY • 91899**

Aluminum roller and ball pen set. Supplied in a padded gift case.  
 ∅ 11 x 138 mm | Case: 175 x 55 x 25 mm  
 LSR - 5 x 35 mm



**DOUBLETTE • 91844**

Metal ball pen and roller set. Both products have touch tips. The set is supplied in a padded gift box.  
 ∅ 10 x 133 mm | Case: 175 x 55 x 25 mm  
 PDP - 6 x 35 mm



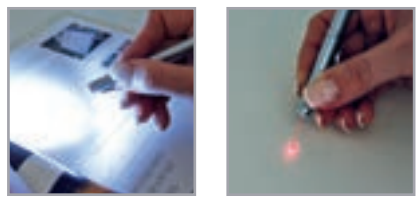
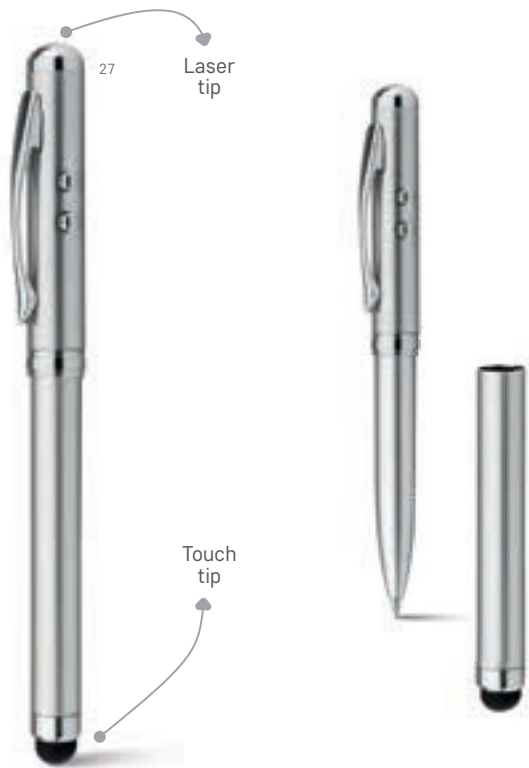

**LAPOINT • 81201**  
 Multifunction metal ball pen with LED, laser pointer and touch tip. This ball pen is supplied in a metal case and includes 3 LR41 batteries.  
 ∅10 x 125 | Box: 178 x 38 x 19  
 PDP - 6 x 50 mm



**IKAROS • 91841**  
 Metal ball pen. This elegant ball pen is supplied in a padded case.  
 ∅11 x 136 mm | Case: 175 x 55 x 25 mm  
 LSR - 5 x 40 mm



**ELLORA • 91362**  
 Metal ball pen with non-slip grip. Supplied in padded gift box.  
 ∅11 x 138 mm | Case: 175 x 55 x 25 mm  
 PDP - 5 x 50 mm

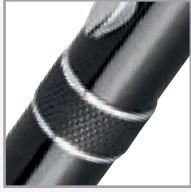

**SINATRA • 91837**

Aluminum ball pen with touch tip.  
Supplied in padded gift box.

∅ 11 x 138 mm | Box: 180 x 43 x 22 mm  
PDP - 5 x 30 mm

03



**CALIOPE • 81197**

Metal ball pen supplied in a craft  
paper case.

∅ 10 x 133 |  
Box: 180 x 43 x 22 mm  
PDP - 7 x 40 mm

03



06



WR



**BERN • 91428**

Roller pen in metal. Supplied in a padded  
gift case.

∅ 12 x 136 mm | Case: 175 x 55 x 25 mm  
PDP - 5 x 35 mm

03

06

07



**CALIOPE ROLLER • 81198**

Metal roller pen with blue refill  
in paper gift box.

∅ Box: 182 x 22 x 42 mm  
PDP - 50 x 6 mm

03



06





05



03

06

04

05



**LANDO • 81190**

Aluminum ball pen.  
 ∅ 11 x 140 mm  
 PDP - 7 x 45 mm



13



04



Laser customisation



**COLLINS • 81127**

Aluminum ball pen. Supplied with gift box (disassembled).  
 ∅ 12 x 136 mm | Case: 150 x 15 x 19 mm  
 PDP - 7 x 50 mm



03



04



**KANT • 81139**

Aluminum ball pen with touch tip. Supplied with a cardboard gift pouch.  
 ∅ 12 x 136 mm | Pouch: 155 x 40 mm  
 LSR - 5 x 35 mm



27



27

04

47



**CONVEX • 91495**

Aluminum and ABS ball pen.  
 ∅ 11 x 145 mm  
 PDP - 6 x 45 mm



### WASS • 81000

Aluminum ball pen with practical and classic design and with a twist mechanism and shiny chrome iron clip. It has a lacquered body with glossy finish and a blue "Cross-type" metal refill of black Dokumental® Ink.

∅10 x 138 mm | Case: 175 x 41 x 20 mm  
 LSR - 5 x 40 mm



### WASS TOUCH • 81005

Aluminum twist ball pen with silicone touch tip. This sophisticated ball pen has a shiny chrome-plated iron clip, glossy finish lacquered body and blue "Cross-type" metal refill of black Dokumental® Ink.

∅10 x 142 mm | Case: 175 x 41 x 20 mm  
 LSR - 5 x 40 mm



### BREL • 91334

Elegant aluminum ball pen.

∅11 x 137 mm  
 PDP - 5 x 50 mm



### RIOJA • 91017

Elegant metal ball pen.

∅10 x 140 mm  
 PDP - 6 x 30 mm





**LANDO ROLLER • 81191**

Aluminum roller pen.  
 ∅ 11 x 140 mm  
 PDP - 7 x 45 mm



**BETA ROLLER • 13574**

Metal roller pen with soft rubber finish.  
 ∅ 11 x 139 mm  
 LSR - 35 x 6 mm



**HUDSON • 91441**



Aluminum ball pen and 0.5 graphite mechanical pencil set. Supplied in gift box.  
 ∅ 11 x 139 mm | Case: 177 x 52 x 22 mm  
 PDP - 7 x 50 mm



**BETA SET • 91649**



Metal ball pen and mechanical pencil set supplied in gift box.  
 ∅ 10 x 138 mm | Box: 174 x 22 x 46 mm  
 PDP - 7 x 55 mm



 **DANEY • 81155**

Elegant aluminum roller pen .  
 ∅ 10 x 136 mm  
 PDP - 6 x 50 mm

 **TOUCH • 51437**

Metal roller pen with touch tip. Supplied with gift box (disassembled).  
 ∅ 9 x 141 mm | Case: 150 x 15 x 19 mm  
 LSR - 5 x 40 mm



 **ALVA • 81157**

Practical aluminum roller pen with rubber finish.  
 ∅ 10 x 136 mm  
 LSR - 5 x 50 mm





27

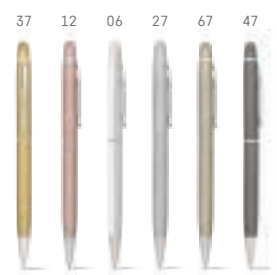

 **JULIE • 81144**

Metal ball pen with touch tip. Supplied in a gift box (disassembled).  
∅ 10 x 141 mm | Case: 150 x 15 x 19 mm  
LSR - 5 x 35 mm



12



 **CLARE • 81156**

Aluminum ball pen with metallic colours.  
∅ 10 x 140 mm  
PDP - 6 x 50 mm



37



 **LEA • 81125**

Elegant aluminum ball pen.  
∅ 10 x 137 mm  
PDP - 7 x 50 mm





**JOAN • 91694**

Aluminum ball pen with matt finish and spring mechanism. The ball pen has a double-finish body, making it suitable for laser engraving.

∅10 x 140 mm  
PDP - 7 x 60 mm

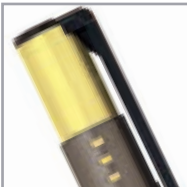

**MATCH • 81143**

Aluminum and ABS ball pen with metallic finish.

∅11 x 142 mm  
PDP - 7 x 70 mm





 **MARIETA SOFT • 81189**  
 Aluminum ball pen with soft rubber finish.  
 ✂ Ø11 x 139 mm  
 ✂ DUV - 6 x 55 mm



 **OLAF SOFT • 81192**  
 Aluminum ballpen with rubber finish and soft touch.  
 ✂ Ø10 x 137 mm  
 ✂ LSR - 7 x 55 mm



**MARIETA • 81187**

Aluminum ball pen.  
 ∅ 11 x 139 mm  
 PDP - 7 x 50 mm



WR



**MARIETA METALLIC • 81188**

Aluminum ball pen.  
 ∅ 11 x 139 mm  
 PDP - 7 x 50 mm



 **BOLT • 81134**

ABS ball pen with metal clip and rubber finish. This ball pen includes gel refill.  
 ∅ 12 x 140 mm  
 PDP - 5 x 45 mm



 **BONO • 91477**

Ball pen with metal clip and gel refill.  
 ∅ 12 x 140 mm  
 PDP - 6 x 26 mm



 **SPACIAL • 81148**

ABS ball pen with cap, gel refill and rubber finished.  
 ∅ 13 x 143 mm  
 PDP - 7 x 45 mm



 **SURYA • 91430**

Ball pen with gel refill.  
 ∅ 12 x 146 mm  
 PDP - 6 x 50 mm



47 27 14



**WALK • 91485**

Aluminum ball pen.  
 ∅ 9 x 140 mm  
 PDP - 5 x 50 mm



03 06 07 04 15 05 47



**LESLEY METALLIC • 81185**

Ball pen with metal clip.  
 ∅ 7 x 129 mm  
 PDP - 5 x 45 mm



03 04 05 28 09



**PETTYS • 12531**



Stainless steel ball pen.  
 ∅ 8 x 131 mm  
 LSR - 50 x 5 mm



47 03 27



**EDGE • 81126**

Aluminum ball pen.  
 ∅ 10 x 147 mm  
 PDP - 7 x 50 mm



03 27 13 23



**LINZ • 81128**

Aluminum ball pen.  
 ∅ 9 x 137 mm  
 LSR - 5 x 40 mm





 **POPPINS • 81140**

Aluminum ball pen with rubber finish.  
 Ø10 x 137 mm  
 LSR - 5 x 50 mm



 **BETA DOMING • 12514**

Metal ball pen suitable for doming customisation.  
 Ø10 x 138 mm  
 DOM - 39 x 5 mm



 **BETA PENCIL • 12577**

Mechanical pencil in metal, 0.5 mm.  
 Ø11 x 139 mm  
 LSR - 55 x 6 mm





**BETA SOFT • 81141**

Aluminum ball pen with rubber finish.

∅10 x 137 mm

DUV - 5 x 50 mm



**BETA • 91311**

Aluminum ball pen with metallic finish.

∅10 x 137 mm

PDP - 5 x 50 mm



**BETA BK • 81165**

Aluminum ball pen.

∅10 x 137 mm

PDP - 5 x 50 mm





 **ZOE BK • 81158**

Aluminum ball pen with touch tip.  
 ∅ 8 x 135 mm  
 LSR - 5 x 50 mm



 **ZOE • 91624**

Aluminum ball pen with touch tip.  
 ∅ 8 x 135 mm  
 SRC - 23 x 37 mm



 **MIRO • 91444**

Aluminum ball pen with touch tip.  
 ∅ 8 x 137 mm  
 PDP - 5 x 45 mm



**BETA TOUCH • 91646**

Aluminum ball pen with touch tip and metallic finish.

∅ 10 x 138 mm  
PDP - 5 x 50 mm



**JOAN • 91849**

Aluminum ball pen with touch tip.

∅ 8 x 142 mm  
PDP - 6 x 55 mm



**JOAN SOFT • 81164**

Metal ball pen with touch tip and soft touch rubber finish.

∅ 8 x 142 mm  
LSR - 5 x 55 mm





 **SANS • 91634**

Ball pen with metal clip, non-slip grip and touch tip.  
 ∅ 11 x 135 mm  
 PDP - 7 x 45 mm

 **SANS BK • 81159**

Ball pen with metal clip, non-slip grip and touch tip.  
 ∅ 11 x 135 mm  
 PDP - 6 x 45 mm



 **ESLA • 91699**

Ball pen with metallic finish, metal clip and touch tip.  
 ∅ 10 x 145 mm  
 PDP - 6 x 45 mm



 **SPECTRA • 91640**

Ball pen with metallic finish and touch tip.  
 ∅ 10 x 140 mm  
 PDP - 6 x 50 mm



 **ARCADA • 91623**

Ball pen with metallic finish and touch tip.  
 ∅ 10 x 137 mm  
 PDP - 5 x 45 mm



03 14 09 37 05 27



**HELIOS • 81137**



Ball pen with light inside and with a metal clip, a non-slip surface and a touch tip. Includes 3 AG3 batteries.

∅ 11 x 135 mm  
PDP - 6 x 45 mm



03 47 27 14 05 28 09



**THEIA • 81183**



Customizable ball pen with logo illuminated with interior LED. This ball pen has a metal clip and touch tip. Includes 3 AG3 batteries.

∅ 11 x 139 mm  
PDP - 7 x 50 mm



03 47 27 14 05 09



**EASEL • 12582**

Ball pen with touch tip and phone holder.

∅ 11 x 143 mm  
PDP - 30 x 4 mm



27 03 14 05



**TECNA • 91642**

Ball pen with metallic finish, touch tip and mobile phone holder.

∅ 11 x 144 mm  
PDP - 6 x 50 mm





22

**AROMA • 81133**

ABS ball pen with metallic finish.

∅ 11 x 146 mm

PDP - 6 x 50 mm



06



03

**CENTUS • 91342**

Ball pen with metal clip.

∅ 13 x 135 mm

PDP - 7 x 50 mm

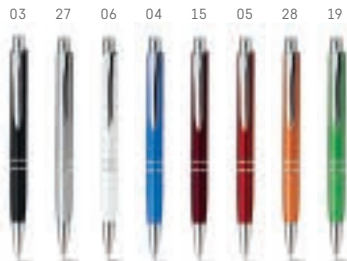

19

**MARIETA PLASTIC • 81178**

Ball pen with metal clip.

∅ 11 x 139 mm

PDP - 7 x 50 mm



28

**BETA PLASTIC • 81182**

Ball pen with metal clip.

∅ 10 x 138 mm

PDP - 7 x 50 mm



03 27 06 14 05



**LENA • 91600**

Ball pen with metal clip.

∅ 10 x 142 mm

PDP - 6 x 40 mm



03 06 05



**GAUSS • 91448**

Ball pen with clip.

∅ 11 x 145 mm

PDP - 6 x 50 mm





04

03 04 15 09 38



**ELBE • 91671**

Ball pen with metal clip and metallic finish.

∅ 10 x 140 mm  
 ▽ SRC - 30 x 52 mm



28

03 47 27 28



**MAGNUS • 12463**

Ball pen with metal clip.

∅ 12 x 144 mm  
 ▽ PDP - 50 x 7 mm



24

03 27 14 24 15 09



**MAYON • 81177**

Ball pen with clip.

∅ 11 x 140 mm  
 ▽ PDP - 7 x 50 mm



02



03 04 32 02 28 08 09



**DIGIT • 12585**

Non-slip ball pen and metal clip.

∅ 13 x 140 mm  
 ▽ DUV - 35 x 8 mm



03



03 06 32 05 28 08



**DIGIT FLAT • 12584**

Non-slip ball pen and metal clip.

∅ 14 x 135 x 11 mm  
 ▽ DUV - 45 x 10 mm



 **MOVE • 81132**

Ball pen with metal clip and non-slip grip.

∅ 12 x 140 mm  
PDP - 7 x 35 mm

 **MOVE BK • 81161**

Ball pen with metal clip and non-slip grip.

∅ 12 x 140 mm  
PDP - 6 x 45 mm



 **SWING • 91019**

Ball pen with metal clip and non-slip grip.

∅ 12 x 140 mm  
PDP - 7 x 35 mm



 **FUNK • 81131**

Ball pen with metal clip and non-slip grip.

∅ 12 x 140 mm  
PDP - 7 x 35 mm







**BRIGT • 91674**

Ball pen with metallic finish.  
 ∅10 x 138 mm  
 PDP - 5 x 45 mm



**MILEY SILVER • 81180**

Non-slip ball pen.  
 ∅11 x 140 mm  
 PDP - 4 x 55 mm



**JANUS • 81154**

ABS ball pen.  
 ∅15 x 143 mm  
 PDP - 6 x 50 mm



### KIWU METALLIC • 81007

ABS ball pen with glossy finish and lacquered top with metallic finish. The ball pen includes X20 refill in blue ink.

∅ 11 x 139 mm

PDP - 7 x 50 mm



### KIWU CHROME • 81008

ABS ball pen with glossy finish and top with chrome finish. The ball pen includes X20 refill in blue ink.

∅ 11 x 139 mm

PDP - 7 x 50 mm





 **TILED • 81130**

Practical and colourful ball pen in ABS and AS.  
 ∅ 11 x 139 mm  
 PDP - 5 x 30 mm



 **CIRCLE • 91643**

Ball pen with rubber finished details.  
 ∅ 12 x 140 mm  
 PDP - 7 x 30 mm



 **BOOP • 81129**

Ball pen with clip.  
 ∅ 11 x 147 mm  
 PDP - 7 x 30 mm





**AURY** • 81152

ABS ball pen.  
 ∅ 11 x 141 mm  
 PDP - 6 x 40 mm



**TOUCAN** • 91396

Ball pen with clip.  
 ∅ 13 x 147 mm  
 PDP - 7 x 40 mm



**STRACED** • 91625

Ball pen with clip.  
 ∅ 11 x 140 mm  
 PDP - 7 x 50 mm





05

03

42



**LIPS • 12597**

Lipstick shaped ball pen.  
 ∅18 x 98 mm  
 PDP - 28 x 8 mm



04



03

04

05

28

08

09



**THICK • 12310**

Non-slip UV metallized ball pen with metal clip.  
 ∅14 x 137 mm  
 PDP - 40 x 8 mm



14

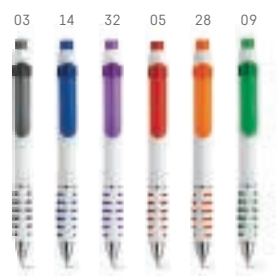

03

14

32

05

28

09



**AISHA • 13925**

Ball pen with clip.  
 ∅12 x 140 mm  
 PDP - 20 x 4 mm



28



03

04

05

28

08

09



**ZELDA • 12581**

Non-slip ball pen with clip.  
 ∅12 x 145 mm  
 PDP - 35 x 3 mm



 **MOLLA • 81174**

Non-slip ball pen.  
 ∅ 13 x 140 mm  
 PDP - 7 x 55 mm



 **DARBY • 81181**

Non-slip ball pen with clip.  
 ∅ 12 x 142 mm  
 PDP - 7 x 50 mm



 **REMEY • 81184**

Non-slip ball pen.  
 ∅ 10 x 138 mm  
 PDP - 6 x 50 mm



 **OCTAVIO • 81176**

Non-slip ball pen.  
 ∅ 10 x 142 mm  
 PDP - 6 x 55 mm





 **KISO • 81102**

ABS ball pen with clip.  
 ∅ 11 x 136 mm  
 PDP - 6 x 50 mm



 **GAIA • 81151**

ABS ball pen with clip.  
 ∅ 11 x 141 mm  
 PDP - 6 x 50 mm

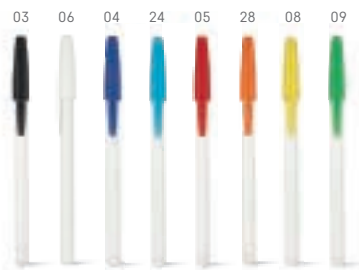

**CARIOCA**

MADE IN EUROPE

 **CORVINA • 91216**

CARIOCA © ball pen with coloured cap.  
 ∅ 10 x 145 mm  
 PDP - 5 x 60 mm



**CARIOCA**

MADE IN EUROPE

 **CORVINA BK • 81169**

Ball pen CARIOCA®.  
 ∅ 10 x 145 mm  
 PDP - 5 x 60 mm



**SUNNY • 91644**

Ball pen with rubber finish.  
 ∅ 11 x 147 mm  
 PDP - 6 x 30 mm



**RIFE • 91645**

Ball pen with clip that has a slot for doming.  
 ∅ 11 x 137 mm  
 DOM - 8 x 42 mm



**CURL • 91633**

Ball pen with metallic finish and non-slip grip.  
 ∅ 10 x 140 mm  
 SRC - 12 x 50 mm



**CARIBE • 91256**

ABS ball pen and non-slip grip.  
 ∅ 10 x 138 mm  
 PDP - 7 x 45 mm









 **AERO • 91635**  
 Ball pen with non-slip grip.  
 ∅10 x 140 mm  
 SRC - 12 x 45 mm



 **MARS CRYSTAL • 91499**  
 Translucent ballpoint pen with clip.  
 ∅10 x 140 mm  
 PDP - 6 x 40 mm





 **MARS • 91498**  
 Ball pen with clip.  
 ∅10 x 140 mm  
 PDP - 6 x 50 mm



 **ANA • 91693**  
 ABS ball pen.  
 ∅10 x 145 mm  
 PDP - 6 x 55 mm



 **SLIM BK • 81160**  
 Practical ball pen with non-slip grip.  
 ∅10 x 145 mm  
 PDP - 7 x 40 mm

 **SLIM • 91247**  
 Practical ball pen with non-slip grip.  
 ∅10 x 145 mm  
 PDP - 7 x 40 mm





09



03 04 05 09

**OCTUS • 81175**

Non-slip ball pen 4 in 1 writing in blue, red, green and black.  
 ∅ 13 x 138 mm  
 PDP - 7 x 40 mm



14



03 27 14 05 19

**MULTIS • 81179**

Non-slip multifunction ball pen 3 in 1: Writes in blue, red and black.  
 ∅ 10 x 148 mm  
 PDP - 7 x 45 mm



03



**SLOPE • 81150**

Ball pen with ABS holder, with sticker on the base to stick to surface.  
 ∅ 90 x 140 x 102 mm |  
 Ball pen: ∅9 x 139 mm  
 PDP - 20 x 50 mm



03



**STAND • 81138**

Ball pen with ABS holder, with sticker on the base to stick to surface.  
 ∅ 60 x 160 x 60 mm |  
 Ball pen: 11 x 11 x 141 mm  
 PDP - 6 x 50 mm

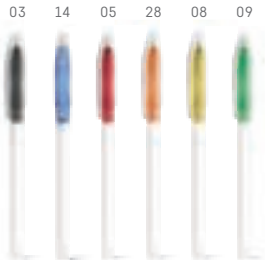

 **LUCY • 81136**

PP ball pen.  
∅ 10 x 142 mm  
PDP - 6 x 50 mm

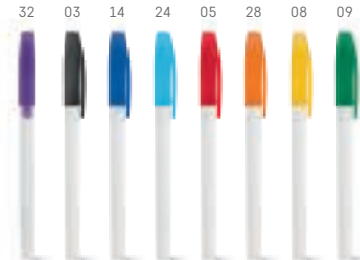

 **JADE • 51110**

PP ball pen.  
∅ 10 x 142 mm  
PDP - 6 x 50 mm



 **LEVI • 81135**

PP ball pen.  
∅ 10 x 142 mm  
PDP - 6 x 50 mm



 **MILU • 51113**

PP ball pen.  
∅ 10 x 142 mm  
PDP - 6 x 50 mm





**CORNWELL • 91716**

Graphite pencil.  
∅ 7 x 190 mm  
PDP - 5 x 100 mm

# MINI PENCIL



**BARTER • 91759**

Mini graphite pencil.  
∅ 7 x 100 mm  
PDP - 5 x 40 mm



**GRAFIT • 91768**

Wooden carpenter's pencil (not sharpened).  
11 x 175 x 7 mm  
PDP - 7 x 50 mm

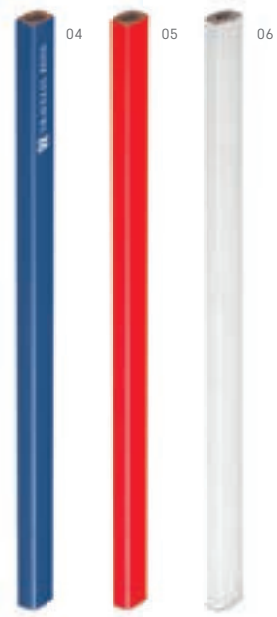

**GRAFIT COLOUR • 91725**

Wooden carpenter's pencil (not sharpened).  
11 x 175 x 7 mm  
PDP - 7 x 50 mm



**ATENEO • 91736**

Graphite pencil.  
∅ 7 x 190 mm  
PDP - 5 x 50 mm



**RIZZOLI • 91738**

Graphite pencil.

∅ 8 x 175 mm

➤ PDP - 5 x 50 mm



**RHOMBUS • 91932**

Writing set that includes 16.5 cm ruler, 2 graphite pencils, 1 eraser and 1 sharpener. This set is supplied in a cardboard pouch.

∅ Pouch: 190 x 45 x 20 mm

➤ SCR - 140 x 35 mm



**ERNSTER • 91721**

Graphite pencil.

∅ 7 x 190 mm

➤ PDP - 5 x 100 mm



**BRENTANO • 91737**

Set of two pencils supplied in cardboard pouch.

∅ Pouch: 190 x 40 x 12 mm

➤ SCR - 140 x 30 mm

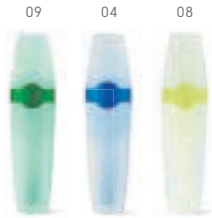

**SPARK • 91613**  
Highlighter in different colours.  
⌄ 26 x 104 mm  
✂ PDP - 7 x 35 mm



**CARIOCA**  
**MADE IN EUROPE**

**MEMORY FLASH • 91604**  
CARIOCA © highlighter in different colours.  
⌄ 15 x 123 mm  
✂ PDP - 5 x 40 mm



 **GRAND • 81211**  
3-in-1 ball pen with blue writing, marker and compartment with 8 coloured paper clips.  
⌄ Ø18 x 149 mm  
✂ PDP - 10 x 50 mm



**TRIAN • 91615**  
TRIAN highlighter with 3 colours.  
⌄ 79 x 79 x 13 mm  
✂ PDP - 35 x 20 mm



**SPEARE • 91969**

Cardboard case for 1 ball pen.  
Interior with elegant velvet cushion.

▮ 170 x 50 x 28 mm  
✂ SCR - 140 x 35 mm



**CASIE • 91955**

Cardboard case for 1 ball pen.  
Interior with elegant velvet cushion.

▮ 175 x 55 x 25 mm  
✂ SCR - 140 x 40 mm



**CORSO • 91951**

Metal case for 1 ball pen.

▮ 178 x 59 x 21 mm  
✂ PDP - 50 x 20 mm



**LELLO • 91973**

Cardboard pouch for 1 ball pen.  
Supplied disassembled.

▮ 150 x 15 x 19 mm  
✂ PDP - 60 x 10 mm



**PENDULO • 91970**

Craft paper case for 1 ball pen.

▮ 180 x 43 x 22 mm  
✂ SCR - 150 x 25 mm





23



03

23

**ADOLIA • 13212**

Gift case for 2 ball pens.  
 174 x 22 x 46 mm  
 PDP - 50 x 15 mm



03

**VILA • 91960**

Velvet pouch for 1 ball pen.  
 160 x 30 mm  
 TRS - 90 x 15 mm



03

**KIKA • 91975**

Gift case for 1 ball pen.  
 165 x 25 x 45 mm  
 PDP - 60 x 10 mm



06

**BERTRAND • 91608**

PVC ball pen pouch.  
 85 x 150 mm  
 PDP - 20 x 50 mm





03



**VIGO • 92144**

ABS travel trolley with lined interior, divider and four swivel wheels. Includes spring-loaded extendable aluminum handle and side-coded safety lock. On the front there is a removable magnet plate suitable for customisation. This trolley has capacity up to 31L and weight of 2.25 kg.

▮ 355 x 550 x 200 mm | Plate: 50 x 20 mm  
 ▮ LSR - 8 x 25 mm



04



**PERTH • 92160**

ABS and PC trolley with lined interior and divider. Contains 4 double swivel wheels, extendable aluminum handle, spring loaded. On the side, has a security lock with code. This trolley has a capacity of up to 33 L and a weight of 2.70 kg.

▮ 335 x 550 x 230 mm  
 ▮ SCR - 100 x 180 mm



27



**BRUGES • 92159**

ABS and PET travel trolley with lined interior and divider. Contains 4 swivel double wheels, spring-loaded aluminum extendable handle and security lock with code on the side. On the front, the trolley has a removable metal plate for customisation. This trolley has a capacity of up to 33L and a weight of 2.70kg.

▮ 335 x 540 x 225 mm | Plate: 60 x 30 mm  
 ▮ LSR - 22 x 45 mm



**KATHRINE • 92125**

600D and EVA toiletry bag with semi-rigid front compartment and lined interior with 2 pockets. The suitcase has a traveling trolley band.

- ☒ 305 x 250 x 85 mm
- ☒ TRS - 150 x 100 mm



**PUEBLA • 92115**

600D and EVA travel trolley with semi-rigid front compartment and lined interior. On the back it has an identification tag and an extendable, spring-loaded aluminum handle. This trolley has capacity up to 28 L.

- ☒ 345 x 520 x 195 mm
- ☒ TRS - 120 x 200 mm



**KANPUR • 52296**

600D EVA Travel Trolley with 2 semi-rigid front compartments, lined interior and interior pocket. On the back it has a label for identification. The trolley has an extendable aluminum handle, with spring and capacity up to 34 L and weight of 2.90 kg.

- ☒ 350 x 530 x 210 mm
- ☒ TRS - 100 x 200 mm



**MELBOURNE • 92142**

600D travel trolley with lined interior and front pockets. On the back, it has a pocket and identification tag. The trolley has an extendable aluminum spring handle and capacity up to 31L.

- ☒ 345 x 540 x 160 mm
- ☒ TRS - 120 x 200 mm



**AVENIR • 92177**



Laptop trolley backpack in 1680D and 300D. Its main compartment is padded and cushioned has a divider for a laptop up to 17". It contains 2 front pockets and 2 zippered side pockets. This trolley has a wheel protector, padded handles, extendable metal spring grip and removable magnet metal plate for customisation. It has capacity up to 22 L and weighs 1.80 kg.

☒ 330 x 490 x 220 mm | Plate: 50 x 20 mm

☞ LSR - 10 x 40 mm



**NOTE • 92283**



1680D and 300D travel trolley backpack with lined laptop compartment for laptop up to 15.6". The backpack has mesh side pockets and 2 front pockets, with several interior pockets. Its handles are padded and the extendable metal handle has a spring. Includes a protective wheel pouch. On the front there is a removable metal plate with magnet for customisation. It has capacity up to 24 L and weighs 1.65 kg.

☒ 350 x 460 x 155 mm | Plate: 50 x 20 mm

☞ LSR - 8 x 25 mm



**MOURA • 92129**



Travel trolley in imitation leather and 1680D with laptop compartment, with hard case. Includes a compartment for a laptop up to 15.6", it is lined and has cushioned interior. On the back there is a label for identification. Contains an extendable, spring-loaded aluminum handle. Removable metal plate with magnet for customisation. The trolley has a capacity of up to 20 L and weighs 2.75 kg.

☒ 430 x 370 x 180 mm | Plate: 50 x 20 mm

☞ LSR - 32 x 10 mm



## EMPIRE BACKPACK

**92680**

The EMPIRE backpack is city and sophisticated in split leather with PU. The main compartment is made of 2 padded dividers, compatible with a laptop up to 14" and a tablet up to 10.5", and several pockets for easy storage. The front has a large pocket. The side zippers have sturdy magnets and metal plates ideal for customisation. The back with padded backrest and fully padded straps ensure maximum comfort and the reinforced bottom corners ensure durability. Interior pockets. Metallic closure. The EMPIRE backpack has a trolley carrying strap, which makes it a versatile and practical object for both everyday and business trips. Supplied in a non-woven bag.

☒ 290 x 370 x 90 mm | Bag: 530 x 500 x 80 mm  
 ✂ LSR - 15 x 15 mm



## EMPIRE SUITCASE II

**92359**

The EMPIRE II is a classic and sophisticated suitcase with two pockets designed to protect your laptop up to 15.6" and your tablet up to 10.5". Its design, like all products in this line, has been thought to the last detail and every detail makes EMPIRE II the ideal folder for an everyday object that goes unnoticed. The EMPIRE II finishing is made of high quality textured imitation leather. The versatility of different transport methods is equally noticeable in its trolley strap. EMPIRE II suitcase is supplied in a non-woven bag.

📏 380 x 280 x 80 mm | Bag: 530 x 500 x 80 mm  
 🛖 LSR - 15 x 15 mm

## EMPIRE SUITCASE I

**92360**

The EMPIRE I is a modern executive suitcase with a sophisticated touch, in high quality textured imitation leather. It has a main compartment with 2 padded pockets, allowing you to store your laptop up to 14" and your tablet up to 10.5". The different ways of carrying this suitcase make it a versatile object, something that is reinforced by its trolley strap. The innovative EMPIRE I magnet closure on the side elevates the suitcase to a single object. All details are focused on its functionality as well as its aesthetics and an example of this are the metallic details used in the handle, which in addition to ensuring the quality of the EMPIRE I, ensure its uniqueness. EMPIRE I suitcase is supplied in a non-woven bag.

📏 370 x 270 x 80 mm | Bag: 530 x 500 x 80 mm  
 🛖 LSR - 15 x 15 mm



**URBAN BACKPACK**  
**92683**



The URBAN is a versatile, high-density soft shell city tarpaulin backpack. Designed to hold a laptop up to 14" and 10.5" tablet. The URBAN's waterproofness makes it a unique object. The impermeability comes both in its fabric and in the design of the zippers that protect the inside of the backpack. The front pocket is spacious and the access to it is very intuitive. The adjustable straps and hand grip contribute to the versatility of the backpack. URBAN is supplied in a non-woven bag.

± 400 x 300 x 70 mm | Bag: 530 x 500 x 80 mm  
✂ TRS - 140 x 160 mm







## DYNAMIC 2 IN 1 BACKPACK

**92682**

The DYNAMIC 2 in 1 is an urban backpack that stands out for its versatility and duality. Its efficient design allows it to be a unique and versatile object that discretely multiplies into a backpack and a travel bag. The backpack has two inside pockets, that allow the protection of your laptop up to 15.6" and your tablet up to 10.5". The large travel bag lets you perfectly organize your clothes for a 2 or 3 day trip. It has an anti-theft back pocket. Material 1680D imitation leather and elastic closures with PU plate. The DYNAMIC 2 in 1 also has a trolley socket that underlines its practical and functional side. The two parts of this backpack can be used separately or as a single piece. Supplied in a non-woven bag.

 300 x 420 x 200 mm | Backpack: 300 x 420 x 75mm |  
 Travel bag: 300 x 420 x 130 mm | Bag: 550 x 580 x 210mm  
 LSR - 40 x 10 mm





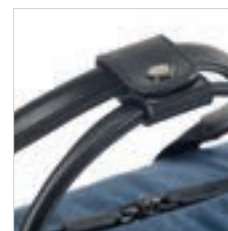
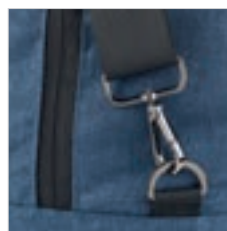
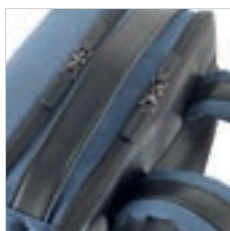

### MOTION BACKPACK 92681



The MOTION is a unique 600D backpack with irreverent design. Split leather with PU. The backpack has several compartments, inside pockets and two padded pockets purposely designed to protect a 15.6" laptop and 10.5" tablet. The padded straps and back accentuate the comfort of this backpack. The trolley strap is yet another feature that emphasizes the practical side of this backpack making it easy to carry around. The flap front pocket and side pockets are equally unique in their design, from the asymmetry of the front pocket to the hidden side pocket that can hold a water bottle. The MOTION is supplied in a non-woven bag.

📏 410 x 330 x 150 mm | Bag: 530 x 500 x 80 mm  
 📏 LSR - 40 x 10 mm

### MOTION BAG 92521



The MOTION is a practical and stylish 600D cationic polyester travel bag with split leather with PU. Its spacious main compartment is ideal for storing clothes and other utilities needed for short trips. It also has four inside pockets and a front pocket with an asymmetrical design flap, which characterizes this line and gives it a modern look. It has a magnet closure. The practicality of this bag is matched by a detailed and careful design that leads to details such as the space to put the name tag, the metallic feet that protect the bag when set down, the design of the zipper that allows it to be closed with a lock (not included) and the straps designed to be adjustable and comfortable. MOTION is supplied in a non-woven bag.

📏 500 x 300 x 250 mm | Bag: 700 x 450 x 75 mm  
 📏 LSR - 40 x 10 mm



**15,6"** ANGLE • 92271

Imitation Leather and 1680D laptop bag . The bag has a padded compartment for a laptop up to 15.6". The interior is lined and padded, with several pockets. It has a front pocket, a back pocket, an adjustable shoulder strap, with padded reinforcement. Contains trolley band.  
 ☒ 410 x 300 x 80 mm | Plate: 40 x 20 mm  
 ⚡ LSR - 30 x 15 mm



**15,6"** ANGLE • 92270

Imitation leather and 1680D backpack. Contains padded compartment for laptop up to 15.6". The interior is lined and padded and contains several interior pockets. The backpack has 2 front pockets. The back is padded and has padded back support and padded straps.  
 ☒ 340 x 450 x 130 mm | Plate: 40 x 20 mm  
 ⚡ LSR - 15 x 30 mm



**13,3"** ZIPPERS • 92287

Laptop bag in 840D jacquard and 300D. Main compartment has padded laptop compartment up to 13.3". The interior is lined and cushioned. The bag has 2 front pockets, adjustable shoulder strap with padded reinforcement and trolley carrying strap.  
 ☒ 360 x 260 x 50 mm  
 ⚡ TRS - 230 x 40 mm



**15,6"** ZIPPERS • 92280

840D jacquard and 300D laptop backpack with 2 compartments. The back compartment is lined and padded, with 2 padded computer compartments up to 15.6" and 10.5" tablet. The front compartment is lined and has several interior pockets. It has 3 front pockets and 2 side pockets. The back is padded, has padded back support and padded straps.  
 ☒ 320 x 450 x 190 mm  
 ⚡ TRS - 45 x 150 mm





Pocket with elastic bands



Earphone output



23

BG

**17"** **BRIDGE • 92165**

840D jacquard and 300D high density laptop bag. It has lined compartment, with 2 padded compartments for laptop up to 17" and tablet up to 10.5". Contains 3 front pockets (with several interior pockets), side pocket and adjustable side compartment with elastic bands. The back is padded, with back support system and padded straps. This backpack has an earphone output and trolley carrying strap. Accessories not included.

- ☒ 330 x 450 x 185 mm
- ☒ TRS - 100 x 150 mm



23

**15,6"** **BRIDGE • 92172**

840D jacquard and 300D high density Laptop bag. This backpack has lined and cushioned compartment, with laptop cushioned partition up to 15.6" and several inner pockets. 3 front pockets and back strap for attachment to trolley. Adjustable shoulder strap with padded reinforcement.

- ☒ 400 x 290 x 70 mm
- ☒ TRS - 130 x 130 mm



**17" BOSTON • 92675**

Waterproof 2Tone Nylon Computer Backpack with 2 compartments. The back compartment is lined, has an interior zippered pocket and padded computer partition up to 17". The front compartment is lined and has several interior pockets. It has 2 front pockets and 2 side pockets. Contains a USB port and USB / micro USB cable for connecting to mobile devices (portable battery not included). The back is padded and has a padded backrest and padded straps. Accessories not included.

± 310 x 470 x 200 mm  
 / TRS - 100 x 150 mm



**15,6" ISTANBUL • 92180**

600D cationic oxford and imitation leather laptop backpack. This backpack is waterproof, resistant to tearing, shrinkage and other deformations. It has 2 compartments. Back compartment with padded divider for laptop up to 15.6". The front compartment has several interior pockets. The interior is lined and cushioned. The back and handles are padded. Contains trolley carrying strap and removable metal plate with magnet for customisation.

± 300 x 430 x 150 mm | Plate: 50 x 20 mm  
 / LSR - 15 x 35 mm

# ANTI-THEFT SYSTEM



15,6"

## AVEIRO • 92176

900D high-density tarpaulin laptop backpack. This backpack has an anti-theft system: main compartment with hidden zipper and back with 2 hidden zippered pockets for added security. The main compartment is lined and padded, with 2 padded dividers for laptop up to 15.6" and for tablet up to 10.5". The backpack has several interior pockets, including a padded smartphone pocket, with earphone output access. Inside, it has cable management clips. On the side, the backpack has a zippered outer pocket, with access to the inner pocket ideal for a portable battery, making it easy to carry multiple devices. The back is padded and has a padded backrest system that makes it ergonomic and comfortable. Its padded shoulder straps have 1 zippered pocket. Accessories not included.

320 x 440 x 200 mm

TRS - 150 x 200 mm





04



**15,6"** **PUNE • 52167**

1680D and 300D laptop bag with 2 compartments. Main compartment is padded and for a laptop up to 15.6", lined interior, 3 front pockets and 2 side pockets. The back is padded, padded back support and padded straps.

☒ 330 x 480 x 180 mm  
 ⚡ TRS - 30 x 100 mm



23



**14"** **KARDON • 92627**

600D polyester laptop backpack for up to 14". This backpack contains 1 all-lined main compartment with two zippered front pockets and interior pockets.

☒ 305 x 445 x 130 mm  
 ⚡ TRS - 100 x 120 mm



03

**15,6"** **OLYMPIA • 92276**

840D Jacquard laptop backpack with 2 compartments. The back compartment is lined and has a padded laptop compartment up to 15.6". The front compartment is lined with several interior pockets. The backpack has side mesh pocket and front pocket. The back is padded and has padded back support and padded straps.

☒ 305 x 470 x 180 mm  
 ⚡ TRS - 50 x 130 mm





33

**15,6"** LUNAR • 92164

600D high density laptop backpack. It has a compartment with 2 padded compartments for a laptop up to 15.6" and tablet up to 9.7". Its interior is lined and cushioned. It has 1 front pocket and 2 side pockets. The back is padded and has padded back support and padded straps.

☒ 290 x 390 x 155 mm  
 ☒ TRS - 150 x 150 mm



33

**17"** NAGOYA • 52166

600D high density computer backpack. The main compartment is lined with a padded computer partition up to 17" and several interior pockets. The backpack has 2 mesh side pockets and 2 front pockets. The back is padded, with padded backrest and padded straps.

☒ 340 x 450 x 175 mm  
 ☒ TRS - 30 x 120 mm

60



15,6"



**NISA** • 92274



Cork laptop bag with padded and lined compartment for laptop up to 15.6". It has a front pocket and adjustable shoulder strap with padded reinforcement. This folder is supplied in a non-woven pouch.

⊞ 410 x 310 x 75 mm | Bag: 490 x 378 mm  
✂ TRS - 40 x 18 mm

13



15,6"

**WILTZ** • 92168



High-density 600D laptop bag with 2 compartments. The back compartment is lined, has several interior pockets and 2 padded compartments for laptop up to 15.6" and for a tablet up to 10.5". The front compartment is lined, ideal for carrying clothes (or for leisure). The back and handles are padded. The backpack has a trolley band.

⊞ 300 x 450 x 160 mm  
✂ TRS - 100 x 200 mm



15,6"

**ADVENTURE • 92174**

Pre-washed cotton canvas laptop backpack. The main compartment is lined, has 2 padded dividers for laptop up to 15.6" and tablet up to 10.5". The backpack has a front pocket and 2 side pockets. The back and handles are padded. It has a trolley carrying strap and imitation leather strap for customisation.

☒ 300 x 420 x 120 mm | Plate: 60 x 30 mm  
 ✂ TRS - 15 x 45 mm

Strap for trolley transportation



11

BG



17"

**TRAVELLER • 92674**

High-density 600D tarpaulin laptop backpack with 2 compartments. The back compartment is lined with several interior pockets and 2 padded dividers for laptop up to 17" and for a tablet up to 10.5". The front compartment is lined and ideal for carrying clothes (or for leisure). The backpack has a front pocket and the back and straps are padded.

☒ 300 x 430 x 150 mm  
 ✂ TRS - 100 x 150 mm



23



04



**14"** **SHADES • 92170**

600D high-density laptop backpack. The main compartment is lined and has 2 padded dividers for laptop up to 14" and tablet up to 9.7". The backpack has a front pocket, 1 side pocket. The back and the straps are padded.

☒ 310 x 400 x 110 mm  
 ✂ TRS - 100 x 140 mm



**14"** **SHADES • 92171**

High density 600D laptop bag. The main compartment is lined and cushioned, with a padded divider for a laptop up to 14". The bag has a front pocket, trolley carry strap and adjustable shoulder strap with padded reinforcement.

☒ 370 x 280 x 50 mm  
 ✂ TRS - 150 x 150 mm



**SHADES • 92173**

High-density 600D shoulder bag with lined compartment for tablet up to 9.7" and several interior pockets. The back is padded. The bag has a front zipper pocket, back pocket and adjustable shoulder strap.

☒ 220 x 270 x 45 mm  
 ✂ TRS - 100 x 140 mm



15.6"

**GRAPHS • 92668**

High density 600D laptop bag with padded compartment for laptop up to 15.6". The interior is lined and padded. The backpack has 2 front pockets, the back and straps are padded.

⊕ 295 x 390 x 100 mm

➤ TRS - 140 x 180 mm



14"

**GRAPHS • 92286**

High-density 600D laptop bag with padded lined compartment up to 14". It has a front pocket, adjustable shoulder strap, with padded reinforcement. The bag has a trolley band.

⊕ 370 x 280 x 50 mm

➤ TRS - 200 x 150 mm



**GRAPHS • 92284**

High-density 600D shoulder bag with padded tablet compartment up to 9.7". The interior is lined and padded. The bag has a front pocket, adjustable shoulder strap with padded reinforcement.

⊕ 220 x 270 x 45 mm

➤ TRS - 90 x 140 mm





03



15"

**ROCCO • 92626**

840D laptop backpack up to 15", with 1 main pocket, 3 additional pockets. Trolley band.  
 300 x 370 x 60 mm  
 TRS - 150 x 150 mm



13

15,6"

**SANTANA • 92266**

600D 2Tone and 300D laptop bag with lined compartment, padded laptop partition up to 15.6". The bag has a front pocket with several interior pockets. Contains trolley carry strap and adjustable shoulder strap with padded reinforcement.  
 400 x 295 x 75 mm  
 TRS - 250 x 120 mm



31



03



04



31

15,6"

**METZ • 92289**

600D laptop bag with compartment for up to 15.6". The interior is lined and padded with interior pockets. It has an adjustable shoulder strap with reinforcement.  
 400 x 290 x 50 mm  
 TRS - 200 x 140 mm



23



23



14



05

15,6"

**BRUSSELS • 92169**

600D laptop backpack. Main compartment has padded divider for laptop up to 15.6". The backpack has side mesh pocket and front pocket. The back and handles are padded.  
 290 x 430 x 100 mm  
 TRS - 120 x 180 mm



**15,6"** VIENA • 92179

High-density 600D laptop backpack with main compartment with padded divider for laptop up to 15.6". The backpack has a zippered front pocket and the back and straps are padded.

▮ 290 x 370 x 110 mm  
 ↗ TRS - 100 x 140 mm



05



**14"** KIEV • 92622

High-density 600D laptop backpack with main compartment with padded divider for laptop up to 14". The backpack has a zippered front pocket and the back and straps are padded.

▮ 290 x 400 x 140 mm  
 ↗ TRS - 120 x 180 mm



05



15,6" CHICAGO • 92258

600D laptop bag, up to 15.6" with lined and padded interior. It has 2 front pockets and adjustable shoulder strap. The bag has a pen holder (pen not included).  
 400 x 300 x 80 mm  
 TRS - 150 x 150 mm



15,6" VIANDEN • 92162

Laptop bag up to 15.6" in 600D. The interior is lined and cushioned, with a front pocket and adjustable shoulder strap with reinforcement.  
 400 x 280 x 60 mm  
 TRS - 200 x 140 mm



14" SEATTLE • 92290

Laptop bag. High density soft shell. For laptop up to 14". With front pocket.  
 370 x 280 x 30 mm  
 TRS - 200 x 100 mm



15,6" HEXA • 92285

600D laptop bag with padded lined compartment for laptop up to 15.6". It has a front zipper pocket and mesh pocket. The bag has adjustable shoulder strap with reinforcement.  
 400 x 290 x 50 mm  
 TRS - 180 x 100 mm





15" **IAN • 72426**

Padded laptop bag up to 15" in 600D polyester with adjustable shoulder strap, 1 main pocket and 2 additional pockets.  
 400 x 310 x 70 mm  
 TRS - 140 x 100 mm



**92352**  
 TECHNOLOGY  
 PG. 113



**92314**  
 TECHNOLOGY  
 PG. 112



14" **GARBI • 92197**

600D polyester document bag with adjustable shoulder strap, 1 main pocket and 2 additional pockets.  
 370 x 290 x 60 mm  
 TRS - 200 x 150 mm





**TANGRAM • 92291**

600D multifunction bag with 2 front pockets and adjustable shoulder strap with reinforcement.

▮ 380 x 300 x 80 mm  
 ↗ TRS - 150 x 140 mm



**NANTES • 92260**

600D multifunction bag with 2 mesh side pockets and front pocket. The bag has an adjustable shoulder strap.

▮ 390 x 300 x 80 mm  
 ↗ TRS - 200 x 150 mm



**SEOUL • 92257**

600D multifunction bag with open (lined) outer compartment with front pocket. This bag has an adjustable shoulder strap.

▮ 400 x 300 x 100 mm  
 ↗ TRS - 200 x 40 mm



**ADALIA • 66511**

600D document bag with main and side pocket.

☒ 385 x 285 x 35 mm  
 ✂ TRS - 250 x 100 mm



**MILO • 92316**

600D polyester document bag with 1 main pocket.

☒ 390 x 300 x 40 mm  
 ✂ TRS - 260 x 150 mm



**DOHA • 92236**

600D document bag.  
 ☒ 390 x 290 x 80 mm  
 ✂ TRS - 280 x 140 mm



**PATH • 92292**

600D document bag with pen holder (pen not included).  
 ☒ 370 x 270 x 50 mm  
 ✂ TRS - 200 x 120 mm



**KAYL • 92357**

Non-woven document bag (80 g/m<sup>2</sup>).

☒ 380 x 300 mm

✂ TXP - 260 x 150 mm



**NASH • 92269**

Non-woven shoulder bag (100 g/m<sup>2</sup>). This bag has velcro closure and 135 cm handle.

☒ 260 x 330 x 60 mm

✂ TXP - 130 x 200 mm



**GERE • 92490**

Non-woven shoulder bag (80 g/m<sup>2</sup>) with 95 cm handle.

☒ 350 x 390 x 60 mm

✂ TXP - 260 x 260 mm



**BERNA • 92667**

600D backpack with front pocket. The back and the straps are padded.

☒ 310 x 410 x 120 mm  
 ✂ TRS - 90 x 140 mm



**KIMI • 92666**

600D backpack, with padded interior and pocket. It has side mesh pockets and front pocket. The back and straps are padded.

☒ 290 x 400 x 150 mm  
 ✂ TRS - 140 x 180 mm

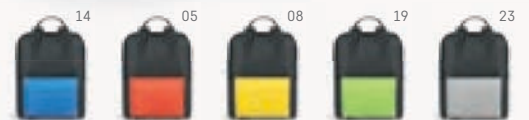

**NIELS • 92676**

600D backpack with front pocket. The back and straps are padded.

☒ 280 x 360 x 100 mm  
 ✂ TRS - 50 x 140 mm



24



**TURIM • 92471**

600D backpack with mesh side pockets and inner pocket. The back and the straps are padded.

☒ 250 x 420 x 180 mm  
 ✂ TRS - 70 x 90 mm



05



**HEDY • 72473**

600D polyester backpack with 1 main pocket, additional pockets and capacity up to 24L.

☒ 280 x 390 x 220 mm  
 ✂ TRS - 110 x 140 mm



31

**WISEU • 92660**

600D backpack with lined interior, mesh side pockets and front pocket. The back and handles are padded.

☒ 300 x 420 x 230 mm  
 ✂ TRS - 70 x 140 mm



24



**CHERINE • 72422**

600D polyester backpack with 1 main pocket, 1 additional pocket and capacity up to 8L.

☒ 230 x 400 x 150 mm  
 ✂ TRS - 100 x 140 mm



## SPORTS BACKPACK



Water container with capacity up to 2L



With whistle



13

BG



### MOUNTI • 92628

420D sports backpack. This backpack has a main compartment and a zippered front pocket. This backpack has a reflective stripe on the front panel that can also be used as a strap. The handles are cushioned, on the back there is a net and there is a carabiner in its main compartment, usually used to hold a water bottle.

▮ 265 x 410 x 55 mm  
 ⚡ TRS - 100 x 100 mm



03

### LANCE • 72185

420D RIPSTOP Polyester cycling backpack with 1 main pocket, 4 additional pockets and capacity up to 5L.

▮ 500 x 350 x 115 mm  
 ⚡ TRS - 90 x 90 mm





**NOLLIE • 72465**

Polyester shoulder bag with adjustable shoulder strap and 1 main pocket.  
 ☿ 380 x 320 x 110 mm  
 ⚡ TRS - 200 x 150 mm



**SHANNON • 92522**

600D polyester bag with adjustable shoulder strap, 1 main pocket and 1 additional pocket.  
 ☿ 230 x 220 x 115 mm  
 ⚡ TRS - 100 x 100 mm



**OLOMOUC • 72425**

600D polyester shoulder bag with adjustable shoulder strap, 1 main pocket and 2 additional pockets.  
 ☿ 175 x 205 x 80 mm  
 ⚡ TRS - 100 x 100 mm





**APRIL • 92545**

High density 600D waist bag with one main compartment and a front zipper. This bag has no adjustable strap with webbing closure.  
 ☒ 220 x 120 mm  
 ⚡ TRS - 120 x 50 mm



**LAHORE • 92547**

600D shoulder bag with front pocket and adjustable shoulder strap.  
 ☒ 180 x 220 x 70 mm  
 ⚡ TRS - 60 x 95 mm



**LAGOS • 92546**

600D waist bag with front pocket.  
 ☒ 210 x 120 x 50 mm  
 ⚡ TRS - 80 x 45 mm



**BARCELONA • 92669**

210D ripstop foldable backpack with front pocket.  
This backpack is supplied unfolded.  
☒ 295 x 415 x 110 mm | Folded: 160 x 130 mm  
🔪 TRS - 55 x 150 mm



**MUNICH • 92569**

210D ripstop waist bag with earphone output.  
☒ 250 x 80 mm  
🔪 TRS - 200 x 25 mm



**TORONTO • 92568**

210D ripstop foldable sports bag with front pocket.  
This bag is supplied unfolded.  
☒ Ø240 x 410 mm | Folded: 160 x 160 mm  
🔪 TRS - 80 x 100 mm



**JOSIE • 72468**

RIPSTOP Foldable 190T polyester sports bag with adjustable shoulder strap, 1 main pocket, 3 additional pockets and capacity up to 25L.  
☒ Folded: Ø240 mm | Open: 440 x 240 x 240 mm  
🔪 TRS - 100 x 100 mm



**NILS • 72432**

420D polyester sports bag with adjustable shoulder strap, 1 main pocket, 1 additional pocket and hard bottom.

▮ 520 x 280 x 280 mm  
 ↗ TRS - 140 x 110 mm



**LOAN • 72428**

600D polyester travel bag with adjustable shoulder strap, 1 main pocket and 4 additional pockets.

▮ 570 x 350 x 250 mm  
 ↗ TRS - 140 x 100 mm



**BUSAN • 92567**

600D sports bag with semi-rigid board inside. This bag has an adjustable shoulder strap with padded reinforcement.

▮ 550 x 310 x 260 mm  
 ↗ TRS - 280 x 60 mm



**FIT • 92511**

600D sports bag with inner dividers and bottom with semi-rigid board. It has a front pocket and side pocket for shoes, both with zipper. This bag has an adjustable shoulder strap.

▮ 520 x 300 x 255 mm  
 ↗ TRS - 200 x 90 mm



05



03

05

19



**HILTON • 72398**

600D polyester travel trolley with hard bottom, extendable metal handle and adjustable shoulder strap. This trolley has 1 main pocket and 1 additional pocket.

▮ 622 x 311 x 318 mm  
 ⚡ TRS - 140 x 90 mm



28



19



05

23

28

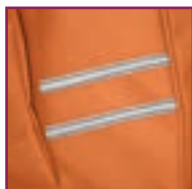

**NORMAN • 72023**

600D polyester sports bag with adjustable shoulder strap, 1 main pocket and 2 additional pockets and hard bottom.

▮ 600 x 330 x 280 mm  
 ⚡ TRS - 140 x 110 mm

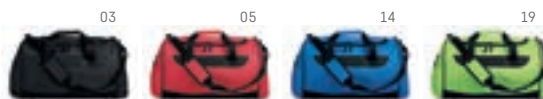

03

05

14

19

**SENNET • 72438**

600D polyester travel bag with adjustable shoulder strap, 1 main pocket, 2 additional pockets and hard bottom.

▮ 560 x 310 x 250 mm  
 ⚡ TRS - 140 x 80 mm

**ZIPPERS • 92516**

Executive sports bag in 840D jacquard and 300D and lined interior. Contains front pockets, bottom with semi-rigid board, adjustable shoulder strap with padded reinforcement.

☒ 520 x 300 x 220 mm  
 ⚡ TRS - 140 x 50 mm



**GIRALDO • 92520**

300D polyester sports bag with adjustable shoulder strap, hard bottom, 1 main pocket and 4 additional pockets.

☒ 640 x 370 x 310 mm  
 ⚡ TRS - 230 x 170 mm



**DETROIT • 92518**

300D and 1680D sports bag with lined interior and bottom with semi-rigid board. The bag has 1 zippered front pocket and 2 side pockets: 1 mesh pocket and another zippered shoe pocket. The shoulder strap is adjustable and has padded reinforcement.

☒ 550 x 300 x 250 mm  
 ⚡ TRS - 200 x 100 mm





**BETO • 92820**

100% cotton canvas bag (280 g/m<sup>2</sup>) with inside pocket and 65 cm handles.  
 450 x 380 x 105 mm  
 TXP - 260 x 260 mm



**EDMONTON • 92822**

100% cotton canvas bag (280 g/m<sup>2</sup>) with inside pocket and 65 cm handles.  
 460 x 400 x 150 mm  
 TXP - 260 x 260 mm



**BRAGA • 92823**

Jute bag (240 gsm) with 65 cm handles and a front 100% cotton pocket (140 gsm).  
 370 x 410 x 100 mm | Pocket: 370 x 270 mm  
 TXP - 150 x 200 mm



**92833**  
 SHOPPING  
 PG. 354

**92856**  
 SHOPPING  
 PG. 355



**LOLLA • 98417**



600D cooler bag with zipper closure. The open outer compartment is lined and has a front pocket. The handles are webbing and 55 cm. The bag holds up to 9L.

± 470 x 305 x 120 mm  
 ↗ TRS - 170 x 120 mm



**98421**

LEISURE & TRAVEL  
 PG. 229



**98422**

LEISURE & TRAVEL  
 PG. 229



**PHILADEL • 98420**



600D cooler bag with 2 different uses. The main compartment has double closure and the interior is lined (with PEVA) and cushioned. The front pocket has a zipper. The webbing straps are adjustable with reinforcement. The bag has a capacity of up to 15 L.

± 480 x 330 x 180 mm | 310 x 240 x 180 mm  
 ↗ TRS - 200 x 45 mm



**AURORA • 72414**



600D polyester cooler bag.  
 ± 365 x 450 x 150 mm  
 ↗ TRS - 110 x 120 mm





**COAST • 98425**



Double-zippered 600D cooler bag, PEVA-lined interior and bottle opener. The upper pocket has zipper and the straps are in webbing with reinforcement. The cooler bag has capacity up to 15 L.

± Ø300 x 260 mm  
 ↗ TRS - 90 x 80 mm



**BASKIT • 98426**



Flexible, double-zippered 600D picnic basket with lined interior. The lunch box has a removable aluminum frame with an ergonomic EVA handle and capacity up to 14 L.

± 460 x 270 x 250 mm  
 ↗ TRS - 140 x 110 mm





06



**SINGAPORE • 98418**



600D cooler bag with adjustable webbing strap and front pocket. The bag holds up to 9L.

± 240 x 220 x 170 mm  
 ↗ TRS - 140 x 100 mm



19



**JAKARTA • 98407**



600D cooler bag with adjustable webbing strap. The bag holds up to 2 of 1.5L bottles.

± 190 x 340 x 100 mm  
 ↗ TRS - 120 x 200 mm



14



19



**MAYFAIR • 98423**



210D folding cooler bag with 60cm webbing handles. This product has a capacity of up to 16 L.

± 400 x 440 x 130 mm  
 ↗ TRS - 80 x 180 mm



**ROTTERDAM • 98410**



Non-woven cooler bag (80 g/m<sup>2</sup>) with velcro closure and front pocket. The bag holds up to 10 L.

± 320 x 350 x 170 mm  
 ↗ TRS - 120 x 150 mm





**LUTON • 98414**



600D cooler bag with adjustable webbing strap and front pocket. The bag holds up to 8 of 0.5L cans.

± 270 x 200 x 160 mm

➤ TRS - 200 x 55 mm



**MELVILLE • 98415**



600D cooler bag with adjustable webbing strap and front pocket. The bag holds up 12L.

± 290 x 340 x 190 mm

➤ TRS - 80 x 200 mm



**GRAYSEN • 72472**



600D polyester cooler backpack.

± 390 x 250 x 160 mm

➤ TRS - 120 x 100 mm



**JAIPUR • 98408**



600D cooler backpack with capacity up to 10 L.

± 280 x 340 x 140 mm

➤ TRS - 90 x 150 mm

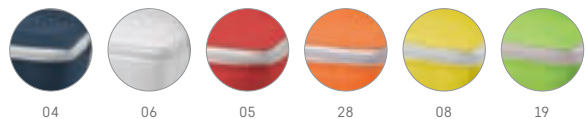

**JEDDAH • 98406**  
 600D cooler bag with capacity up to 6 0.33L cans.  
 200 x 140 x 125 mm  
 TRS - 150 x 90 mm



**IZMIR • 98409**  
 Non-woven cooler bag (80 g/m<sup>2</sup>) with capacity up to 6 cans of 0.33 L.  
 200 x 140 x 130 mm  
 TRS - 150 x 90 mm

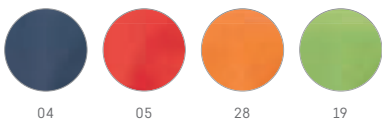

**OSAKA • 98413**  
 Non-woven folding cooler bag (80 g/m<sup>2</sup>) with velcro closure. This bag is supplied unfolded and has a capacity of up to 3 L.  
 Folded: 170 x 95 x 40 mm |  
 Open: 170 x 265 x 110 mm  
 TRS - 130 x 35 mm



**SEBASTIAN • 98416**  
 600D cooler bag with adjustable webbing strap and capacity up to 3 L.  
 190 x 230 x 80 mm  
 TRS - 90 x 150 mm

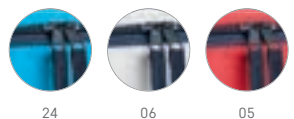

**TURTLE • 58412**  
 600D cooler bag with adjustable webbing strap.  
 200 x 200 x 110 mm  
 TRS - 120 x 120 mm





### VILLA • 98422



High density 600D cooler picnic backpack. The backpack has a removable blanket and thermos bag. The main compartment is padded and has thermal coating. The front pocket is lined in 210D and padded. The front pocket has a removable utensil holder that includes 12 stainless steel cutlery (4 forks, 4 knives and 4 spoons), 4 plates, 4 PS cups, 4 cotton napkins, 1 salt shaker, 1 pepper shaker, 1 PP board and 1 corkscrew. The bottle bag and main compartment are fully lined (with PEVA) and cushioned. The blanket in polar fabric 160 g/m<sup>2</sup>, lined with PEVA.

☒ 300 x 410 x 120 mm | Bottle pouch: Ø105 x 300 mm |

Blanket: 1500 x 1350 mm

☞ TRS - 100 x 140 mm



11

LT



### ARBOR • 98421



600D cooler picnic backpack with removable thermos bag. The main compartment is cushioned with thermal lining, 210D lined front pocket and padded. Includes 6 stainless steel cutlery (2 forks, 2 knives and 2 spoons), 2 plates, 2 PS glasses and 1 corkscrew. The bottle bag and main compartment are fully lined (with PEVA) and cushioned.

☒ 280 x 390 x 120 mm | Bottle pouch: Ø105 x 300 mm

☞ TRS - 100 x 140 mm



04



03



**THRONE • 98131**

600D foldable chair with metal construction and supports up to 100 kg. This chair is supplied in a pouch.

⊞ Unfolded: 520 x 520 x 830 mm | Folded: 830 x 160 mm

➤ TRS - 230 x 60 mm



19



04



03

31

04

05

28

19

**THORPE • 99074**

Polar fabric blanket (180 g/m<sup>2</sup>) and removable handle.

⊞ 1500 x 1200 mm

➤ TRS - 95 x 40 mm



**BASKIT • 98426**



Flexible, double-zippered 600D picnic basket with lined interior. The lunch box has a removable aluminum frame with an ergonomic EVA handle and capacity up to up to 14 L.

▮ 460 x 270 x 250 mm  
 ↗ TRS - 140 x 110 mm



**RILEY • 99076**

EPE-lined (180 g/m<sup>2</sup>) fleece blanket with 600D flap with carry handle.

▮ 1450 x 1200 mm | Folded: 450 x 230 mm |  
 Flap: 300 x 200 mm  
 ↗ TRS - 180 x 80 mm



**FLEECE • 99077**

EPE-lined (160 g/m<sup>2</sup>) fleece blanket with handle and shoulder strap.

▮ 1500 x 1200 mm | Folded: Ø150 x 315 mm  
 ↗ TRS - 225 x 60 mm





MADE IN EUROPE

### GOLFI • 99964

Cotton golf towel (430 g/m<sup>2</sup>) with metal hook.

☒ 380 x 500 mm | Strip: 380 x 42 mm

✂ TRS - 30 x 230 mm



### CLUBBER • 98127

Plastic brush for golf with carabiner.

☒ 180 x 50 mm

✂ PDP - 50 x 7 mm



MADE IN EUROPE

### CANCHA • 99962

Cotton sports towel (430 g/m<sup>2</sup>).

☒ 300 x 500 mm | Strip: 300 x 56 mm

✂ TRS - 40 x 270 mm



MADE IN EUROPE

### GEHRIG • 99963

Cotton sports towel (430 g/m<sup>2</sup>).

☒ 500 x 800 mm | Strip: 500 x 75 mm

✂ TRS - 60 x 270 mm



### TRAVIS • 99966

Microfiber sports towel (210 g/m<sup>2</sup>).  
Supplied with 190T pouch.

☒ 400 x 800 mm | Pouch: 135 x 205 mm

✂ TRS - 80 x 80 mm





# REFRESHING SPORTS TOWEL!

LT



## ARTX • 99968

Polyamide and polyester sports towel. Refreshing towel when wet stays cold for a few hours. If it warms up, just shake it, reactivating its freshness. This product is machine washable, making it reusable.

- ▮ 300 x 800 mm
- ▮ TRS - 150 x 200 mm



## JULES • 99967

Practical polyamide and polyester sports towel with bottle-shaped packaging. PP and PET bottle. The towel is refreshing and when wet stays cool for a few hours. If it warms up, just shake it, reactivating its freshness. This product is machine washable, making it reusable. The bottle has a hook included. Capacity up to 440 ml.

- ▮ Towel: 300 x 800 mm | Bottle: Ø65 x 125 mm
- ▮ TRS - 200 x 280 mm

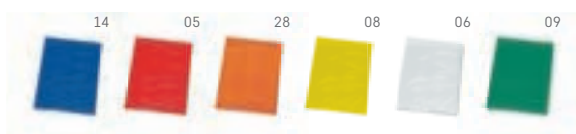

### SAINZ • 98454

Cheer sticks. This set of 2 sticks is supplied (each one of them) with a straw to fill them.

∅ 600 x 100 mm  
 ↗ SCR - 270 x 70 mm



### TRUDY • 93398

Aluminum keyring with whistle.

∅ 07 x 45 mm  
 ↗ LSR - 6 x 28 mm



### CLAPPY • 98073

Useful and fun hand clapper.

∅ 85 x 185 x 19 mm  
 ↗ PDP - 25 x 25 mm

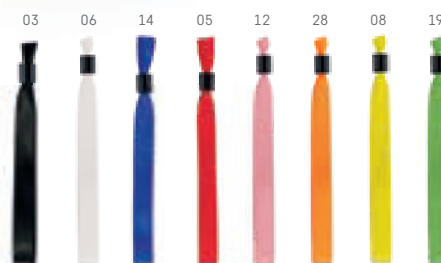

### SECCUR • 94970

Satin invariable bracelet with security lock.

∅ 320 x 15 mm  
 ↗ SCR - 200 x 10 mm



**RUBLEV • 98709**

Football.

Size 5

TR - 40 x 40 mm



**CROSSLINE • 98712**

Football.

Size 5

TR - 40 x 40 mm



**VOLEI • 98711**

Volleyball.

Size 5

TR - 60 x 35 mm



**ANDREI • 98710**

Football.

Size 5

TR - 40 x 40 mm



### RELAX • 98096

Badminton set includes 2x aluminium rackets,  
2x plastic shuttlecocks.

☒ Pouch: 670 x 265 mm

☒ TXP - 120 x 100 mm

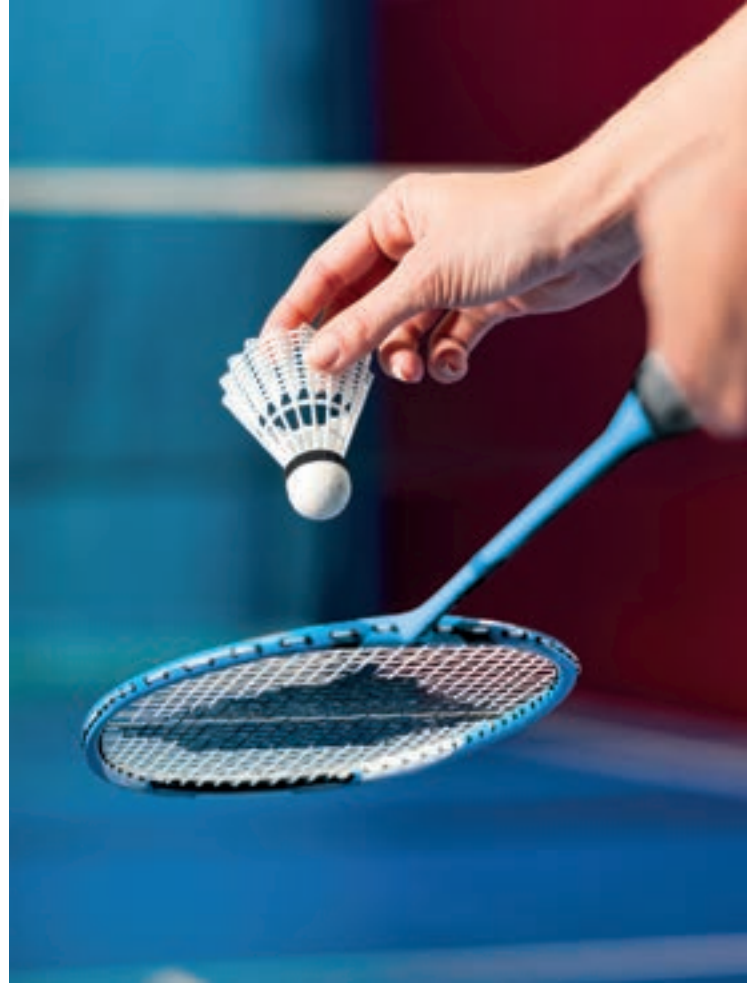

### BRADY • 98086

Practical fitness set that includes elastic  
and skipping rope. Supplied in 190T bag.

☒ Pouch: 210 x 270 mm

☒ TRS - 150 x 150 mm



### RUNY • 97203

Pedometer with 1 AG10 battery included.

☒ 47 x 35 x 20 mm

☒ PDP - 15 x 6 mm



**BRYANT • 97206**

High-density soft shell e PU armband for smartphone up to 5". The armband has reflective elements and adjustable closure. This is a promotional product.

▮ 430 x 150 mm  
 ✂ PDP - 40 x 25 mm



**CONFOR • 97207**

High density soft shell armband for smartphone up to 5.5". The armband has reflective elements and adjustable closure. This is a promotional product.

▮ 440 x 175 mm  
 ✂ PDP - 40 x 27 mm



**KOV • 99022**

Polyester wrist band with appropriate area for customisation.

▮ 75 x 78 mm  
 ✂ TRS - Ø25 mm



**PICCHU • 99023**

Polyester wrist band with zippered pocket.

▮ 100 x 100 mm  
 ✂ TRS - 50 x 50 mm



**LED** SEE • 21129

4-LED flashlight with reflector and flash function. This flashlight has 3 modes and includes batteries.

▮ Torch 53 x 13 x 30 mm | Silicone band: 70 x 4 x 35 mm  
 ⚡ PDP - 4 x 20 mm



**LED** MOLLEMA • 98512

ABS reflective light with 2 LEDs, 2 light modes and clip on the back. Includes 2 CR1220 batteries.

▮ 30 x 61 x 16 mm  
 ⚡ PDP - 15 x 30 mm



**LED** LABYR • 98511

Eco-friendly ABS and PVC reflective light with 2 LEDs and 2 light modes, ideal for sneakers. Includes 2 CR2016 batteries

▮ 63 x 89 x 28 mm  
 ⚡ PDP - 10 x 12 mm

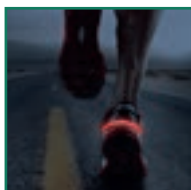

**LED COB** HARRIER • 94742

ABS flashlight with LED COB (steerable light) and clip. This flashlight is ideal for caps and includes 3 LR44 batteries.

▮ 55 x 53 x 22 mm  
 ⚡ PDP - 40 x 25 mm



**DIRECTIONAL LIGHT**  
 With clip to put on cap or backpack



LT



**LED** **LATOK • 94756**

LED tubular flashlight with carabiner. This flashlight has an on/off mechanism and 4 LR41 batteries.

▮ 136 x 18 mm  
 ▮ PDP - 60 x 8 mm



**LED** **DROMO • 94741**

ABS and AS flashlight with 2 LEDs and 3 light modes including fluorescent effect. Includes 3 LR41 batteries.

▮ 22 x 18 x 120 mm  
 ▮ PDP - 50 x 10 mm



### YELLOWSTONE • 98503

100% polyester high visibility vest certified with EN ISO 20471 class 2. This vest has 2 horizontal reflective bands and a velcro front opening.

📏 One size: 670 x 700 mm  
 🗑️ TRS - 140 x 100 mm



### THIEM • 98502

100% polyester reflective vest with EN1150 certificate. This vest has 2 horizontal reflective bands, side elastics. This product is not for professional use.

📏 One size: 540 x 620 mm  
 🗑️ TRS - 170 x 280 mm



### MIKE • 98501

100% polyester reflective childrens vest. This product contains 2 horizontal reflective bands, a side velcro closure and has EN1150 certification. This product is not intended for professional use.

📏 One size: 370 x 470 mm  
 🗑️ TRS - 40 x 230 mm



### ROGER • 98504

100% polyester pouch. Suitable for vest 98503.

📏 145 x 220 mm  
 🗑️ TRS - 100 x 150 mm





### ILLUSION • 98510

Waterproof backpack protection in 210D with reflective elements. This is a promotional product.

Size: 660 x 770 mm  
 TRS - 200 x 230 mm



### RULES • 92835

210D drawstring bag with reflective elements. This product is a promotional product.

Size: 350 x 400 mm  
 TXP - 160 x 250 mm



### JONES • 99418

Polyester cap with reflective elements and adjustable velcro. This is a promotional product.

Size: 580 mm  
 TRS - 90 x 55 mm



**NIBALI • 98821**

Reflective light with 3 LEDs, 3 light modes and carabiner. This light includes 2 CR1220 batteries.

⊥ 55 x 75 mm  
 ↗ PDP - Ø35 mm



**RESIDENCE • 93340**

Fluorescent house shaped keyring.

⊥ 55 x 56 mm  
 ↗ PDP - 30 x 30 mm



**BERRY • 93339**

Fluorescent bear shaped keyring.

⊥ 60 x 66 mm  
 ↗ PDP - 20 x 50 mm



**HOWIE • 95880**

Fluorescent triangular shaped keyring.

⊥ 47 x 41 mm  
 ↗ PDP - 30 x 20 mm



**LED** **VISIBLE • 98515**

Reflective armband with 4 red LEDs, flash function and velcro with EN 13356 certification.

± 30 x 410 mm  
 PDP - 10 x 20 mm



**FLORIAN • 98514**

Elastic reflective polyester band with EN 13356 certification.

± 610 mm  
 TRS - 100 x 8 mm



**RAFAEL • 98505**

Fluorescent bracelet with velvet lining. This is a promotional product.

± 300 x 30 mm  
 PDP - 65 x 12 mm



### ZIKMUND • 98816

Metal compass in plastic casing.  
Product supplied in box.

∅ 55 x 25 mm  
PDP - 20 x 10 mm



### CLOSE • 98824

Aluminum carabiner with bottle opener.  
This product is not suitable for climbing.

44 x 79 x 3 mm  
PDP - 5 x 40 mm



### GALILEY • 98808

Practical compass.  
∅ 45 x 15 mm  
PDP - ∅30 mm



### CYRIL • 98825

Compass with magnifying glass  
and string.

110 x 17 x 60 mm  
PDP - 35 x 7 mm



**LED STANY • 94747**

Headlamp with elastic strap, 8 white LEDs and 2 red LEDs, flash function. Includes 3 AAA batteries.

⊥ 80 x 40 x 60 mm  
 ↗ PDP - 25 x 10 mm

**TORCH**  
 with various light modes  
 and positioning

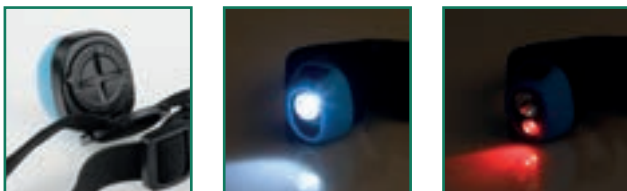

**LED HADIR • 21133**

Water resistant headlamp with LED and red LED. Includes 2 batteries.

⊥ 31 x 36 x 28 mm  
 ↗ PDP - 7 x 15 mm



**LED BEAMER • 94757**

ABS headlamp with buckle, 1 white lamp (1W), 2 red LEDs with flash function. Includes 2 CR2032 lithium batteries. This headlamp is supplied in a box.

⊥ 55 x 38 x 45 mm  
 ↗ PDP - 10 x 5 mm



### MERIBEL III • 94228

3 m tape measure with brake and metal clip.  
This tape measure is MID certified.

⊘ 72 x 52 x 26 mm  
➤ PDP - 25 x 10 mm



### MERIBEL V • 94229

5 m tape measure with brake and metal clip.  
This tape measure is MID certified.

⊘ 88 x 61 x 31 mm  
➤ PDP - 25 x 10 mm



3m

**GULIVER III • 94210**

3 m ABS tape measure with brake and metal clip.  
 ☒ 60 x 60 x 35 mm  
 ✂ STI - 35 x 30 mm



14

5m

**GULIVER V • 94230**

5 m ABS tape measure with brake and metal clip.  
 ☒ 75 x 70 x 40 mm  
 ✂ STI - 40 x 37 mm



14

05

08



08



08

3m

**VANCOUVER III • 94232**

3 m tape measure with ABS brake with metal clip and a nylon wrist band. This tape measure is MID certified.  
 ☒ 74 x 55 x 38 mm  
 ✂ PDP - 25 x 10 mm

5m

**VANCOUVER V • 94233**

5 m tape measure with ABS brake with metal clip and a nylon wrist band. This tape measure is MID certified.  
 ☒ 86 x 64 x 42 mm  
 ✂ PDP - 30 x 15 mm

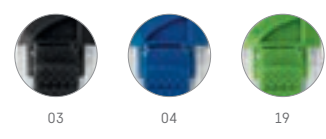

**PAYTON • 94510**

Cutter  
 155 x 30 x 10 mm  
 PDP - 50 x 10 mm

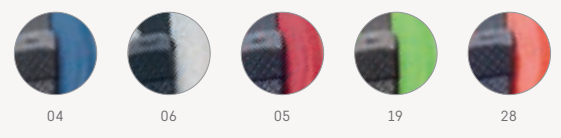

**BALIC • 94501**

Cutter  
 130 x 20 x 8 mm  
 PDP - 55 x 7 mm



**GRAFIT • 91768**

Wooden carpenter's pencil (not sharpened).  
 11 x 175 x 7 mm  
 PDP - 7 x 50 mm

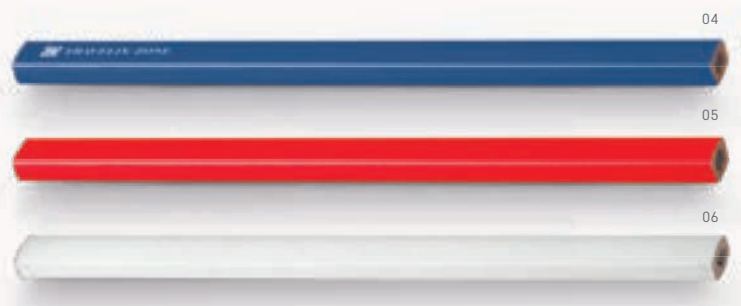

**GRAFIT COLOUR • 91725**

Wooden carpenter's pencil (not sharpened).  
 11 x 175 x 7 mm  
 PDP - 7 x 50 mm



Inox

**SPIKER • 82475**

Mini stainless steel and metal pocket knife with safety lock and keyring.  
 63 x 7 x 27 mm  
 LSR - 45 x 12 mm





Inox

**ALICK • 94035**



Pocket knife with safety lock, in stainless steel and metal. This product is supplied in a box.

∓ 97 x 15 x 29 mm | Box: 110 x 37 x 20 mm  
 ✂ PDP - 45 x 15 mm



03



Inox

**NINJA • 94036**



Pocket knife with safety lock, in stainless steel and metal. This product is supplied in a box.

∓ 115 x 15 x 32 mm | Box: 125 x 42 x 20  
 ✂ LSR - 35 x 10 mm



03



Inox

**FRED • 94037**

Pocket knife with safety lock and carabiner in stainless steel and metal. This product is supplied in a box.

∓ 101 x 10 x 29 mm | Box: 108 x 39 x 15 mm  
 ✂ LSR - 30 x 8 mm



03

60



Inox

**SPLIT • 94038**

Stainless steel and wooden pocket knife with safety lock. Product supplied in a box.

☒ 84 x 11 x 24 mm | Box: 94 x 33 x 16

🔪 LSR - 30 x 10 mm



60



Inox

**GUNTER • 94033**

Stainless steel and wood pocket knife with carabiner. This product is supplied in a box.

☒ 115 x 13 x 26 mm

🔪 PDP - 55 x 10 mm



27



Inox

**GARMISCH • 94185**

Stainless steel and metal knife.

☒ 75 x 26 x 6 mm

🔪 LSR - 40 x 10 mm

60



Inox

**BELPIANO • 94159**

Stainless steel and wood multifunction pocket knife with 5 functions.

☒ 90 x 25 x 12 mm

🔪 PDP - 50 x 8 mm



70



Inox

**FALCON II • 94031**

Pocket knife with security lock in stainless steel and wood.

✂ 110 x 19 x 30 mm

✂ LSR - 15 x 15 mm



Inox

**LAWRENCE • 94030**

Stainless steel and wood pocket knife with security lock.

✂ 115 x 16 x 36 mm

✂ LSR - 60 x 10 mm



70



Inox

**NORRIS • 94032**

Stainless steel and wooden hunting knife, supplied in 600D pouch.

✂ 300 x 19 x 60 mm

✂ LSR - 60 x 15 mm



70



Inox **GRODEN • 94155**

Stainless steel and plastic multifunction pocket knife with 13 functions.

☒ 90 x 20 x 17 mm

☒ PDP - 50 x 7 mm



Inox **KAPRUN • 94147**

Stainless steel and metal multifunction pocket knife with 11 functions.

☒ 90 x 25 x 18 mm

☒ LSR - 50 x 7 mm



Inox **SPENCER • 94034**

7-function pocket knife in stainless steel and rubber. Product supplied in a box.

☒ 74 x 15 x 23 mm

☒ LSR - 40 x 10 mm



**VERBIER • 94192**

ABS and metal multifunction pocket knife with 5 functions.

☒ 59 x 17 x 8 mm

☒ PDP - 40 x 9 mm

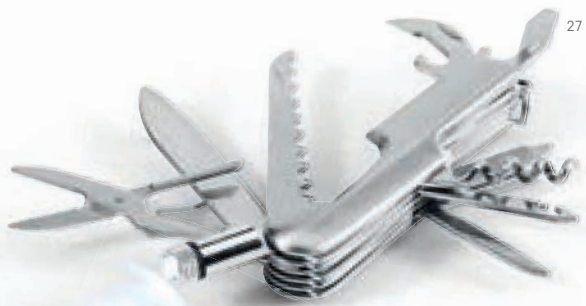

27

Inox

**SOLDEN • 94131**

LED

Stainless steel and metal multifunction knife with mini LED flashlight. This pocket knife has 11 functions including the mini LED flashlight (includes 3 AG10 batteries).

☰ 90 x 20 x 27 mm  
 ↗ LSR - 40 x 8 mm



03

Inox

**WILD • 94040**

☑

12-piece stainless steel army knife. Product supplied in box.

☰ 89 x 16 x 32 mm | Box: 104 x 39 x 20  
 ↗ LSR - 25 x 7 mm



27

Inox

**ARAD • 94133**

LED

Outdoor kit in stainless steel, metal and aluminum. This kit had a multifunction pocket knife with 11 functions and flashlight (includes 3 AAA batteries). Supplied in a 600D pouch.

☰ Pouch: 84 x 120 x 25 mm  
 ↗ TRS - 45 x 25 mm



27

Inox

**LOFER • 94187**

LED

Stainless steel and metal multifunction pocket knife with 11 functions, compass and flashlight (includes 3 AG1 batteries). This kit comes in a 600D bag.

☰ Pouch: 55 x 100 x 34 mm  
 ↗ LSR - 25 x 6 mm



Inox

**MAGNUM • 94022**

19-function stainless steel and wood multifunction tool set supplied in polyester pouch.

☞ Pouch: 140 x 30 x 65 mm  
 ☞ PDP - 30 x 25 mm



Inox

**DUNITO • 94016**

9-function stainless steel and aluminum mini-pliers. Supplied in a 600D pouch.

☞ Closed: 35 x 70 x 18 mm | Pouch: 50 x 90 x 20 mm  
 ☞ LSR - 4 x 25 mm





03

LT

**TUFF • 94019**

45 piece PE and carbon steel tool set  
supplied in a case.

▮ 220 x 115 x 55 mm

▮ PDP - 50 x 20 mm



**BENNET • 94021**

32-piece tool set provided in 600D polyester pouch.

▮ 158 x 108 x 37 mm

▮ TRS - 100 x 70 mm



05



**GABRO • 94017**

ABS tool set with clip, 4 LEDs and 5 wrenches. Includes 2 AAA batteries.

- ▮ 90 x 30 x 35 mm
- ▮ PDP - 20 x 8 mm

**ROGLIC • 94009**

11 wrench bike tool kit, 2 tire levers, 6 tire patches, glue tube and scraper. Supplied in a 600D bag.

- ▮ Pouch: 95 x 120 x 36 mm
- ▮ TRS - 50 x 30 mm

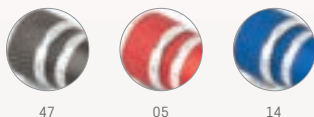
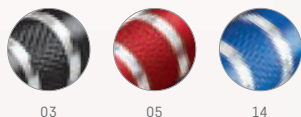

**TOOLPEN • 94014**

Metal mini tool set with 8 wrenches.

- ▮ Ø16 x 109 mm
- ▮ PDP - 8 x 30 mm

**BASALT • 94020**

Metal mini tool set and 3 screwdriver bits.

- ▮ Ø13 x 75 mm
- ▮ LSR - 6 x 30 mm

**CHERT • 94018**

PS mini tool set with 4 screwdriver bits.

- ▮ 92 x 22 x 13 mm
- ▮ SCR - 50 x 10 mm





**WIGGINS • 72292**

Polyester bicycle bag with earphone outlet and reflective elements. This bag has 1 main pocket and 1 additional phone pocket with tactile window.

▮ 90 x 100 x 190 mm  
 ⚡ TRS - 15 x 50 mm



**LED TWICE • 98513**

Set of 2 ABS signal lamps, with 2 red LEDs and 2 white LEDs with flash function. Includes 4 CR 2025 lithium batteries. This set is supplied in a box.

▮ 80 x 52 x 22 mm  
 ⚡ PDP - 17 x 5 mm



**YATES • 92799**

600D bicycle case with 3 adjustable straps.

▮ 230 x 200 x 60 mm  
 ⚡ TRS - 90 x 45 mm



05



04



05



23



With magnet on the back



**PAVIA • 94739**



ABS flashlight with LED COB, hanging hook and magnet. Includes 3 AAA batteries.

⊥ 61 x 200 x 35 mm

⚡ PDP - 15 x 40 mm



28



**CAMPER • 21120**



Flashlight with 27 LEDs with wrist strap and magnet. Requires 3 AAA batteries (not included).

⊥ 62 x 96 x 34 mm

⚡ PDP - 30 x 10 mm



With magnet on the back



23



05



04



**HANK • 94740**



ABS flashlight with LED COB, carabiner and magnet. Includes 2 CR2032 batteries.

⊥ 35 x 74 x 24 mm

⚡ PDP - 5 x 20 mm



With magnet on the back



07



**NOBEND • 94749**



Metal extendable LED flashlight with 3 LEDs, magnet and clip. Includes 4 LR44 lithium batteries.  
 ⚓ Ø22 x 175 mm  
 ⚡ LSR - 5 x 30 mm



03



**GRANJA • 94738**

Aluminum flashlight with LED. This flashlight includes 2 AA batteries and is supplied in a gift box.

⚓ Ø29 x 163 mm | Box: 35 x 175 x 35 mm  
 ⚡ LSR - 7 x 50 mm



05



03

04

05



**ZOOMIN • 94758**

Aluminum flashlight with 3 light modes zoom function, with 1 W lamp LED and supplied in a gift box. Includes 3 AAA batteries.

⚓ Box: 115 x 43 x 40 mm  
 ⚡ LSR - 40 x 10 mm



**SADO • 94734**

Aluminum flashlight with 6 LEDs.  
Includes 2 CR2032 batteries.

- ∅ 25 x 49 mm
- LSR - 9 x 20 mm



**LOUIS • 94732**

Aluminum flashlight with 6 LEDs.  
Includes 2 CR2032 batteries.

- 28 x 40 x 28 mm
- LSR - 20 x 20 mm



**EDDIE • 94720**



Dynamo flashlight with 3 LEDs. This product includes 3 AG10 batteries.

- 100 x 50 x 25 mm
- PDP - 45 x 20 mm



**CASTOR • 21132**

Flashlight with 3 LEDs and metal buckle.  
Includes 2 batteries.

- 43 x 133 x 10 mm
- PDP - 50 x 15 mm





**LED SEVAL • 21109**

Metal LED flashlight with 3 LEDs and wrist strap supplied in a paper gift box. Requires 1 AAA battery (not included).

Box: 122 x 28 x 65 mm  
 LSR - 25 x 7 mm



**LED FLASHY • 94736**

Aluminum 9-LED flashlight that includes 3 AAA batteries.

Ø26 x 90 mm  
 LSR - 9 x 20 mm



**LED BRIGHTER • 94746**

Aluminum flashlight with interior LED. This flashlight includes 4 LR44 batteries and is supplied in a gift box.

Closed: Ø17 x 65 mm | Box: 73 x 33 x 25 mm  
 LSR - 8 x 30 mm





24

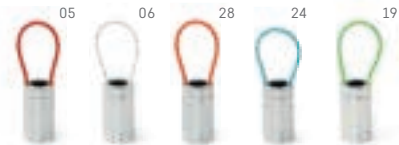

LED

**SHINE • 94752**

Aluminum 6-LED flashlight with a "glow in the dark" silicone handle. This flashlight includes 2 CR2032 batteries.

∅ 25 x 48 mm | Silicone band: 60mm  
 LSR - 7 x 25 mm



DECAPSULATOR

03

MAGNET

LED  
COB

**CORTS • 94745**



LED COB aluminum flashlight, bottle opener, carabiner and magnet. The flashlight includes 5 LR44 batteries.

∅ 15 x 130 mm  
 LSR - 6 x 30 mm



05



LED

**TORCHEN • 93267**

Metal flashlight with 3 LEDs, bottle opener and keyring. 3 LR44 batteries included.

∅ 18 x 72 mm  
 LSR - 7 x 25 mm

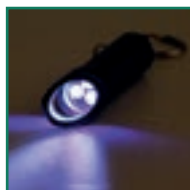



Decapsulator

LED

**MIRA • 94754**

Aluminum flashlight with 1 LED, a bottle opener and silicone wrist band. This flashlight includes 3 LR44 batteries.  
 ∅ 17 x 73 mm | Silicone band: 60 mm  
 PDP - 7 x 28 mm



Tablet compartment

LED

**MAYOR • 94755**

Aluminum flashlight with 1 LED, pill compartment and silicone wrist band. This flashlight includes 3 LR44 batteries.  
 ∅ 17 x 73 mm | Silicone band: 60 mm  
 PDP - 7 x 28 mm



LED  
COB**EVEREST • 94753**

ABS camping lantern with 3 LED COB. This flashlight has metal handles and 3 AAA batteries included. Product supplied in a white cardboard box.

∅ 69 x 185 mm  
PDP - 030 mm

**SHOCK SENSOR**

LED

**CAPSULE • 21131**

Plastic flashlight with 5 LEDs and touch on/off sensor. Includes 2 batteries.

∅ 44 x 80 mm  
PDP - 20 x 15 mm







**LED PUSHLITE • 21127**

LED flashlight with hook. Requires 3 AAA batteries (not included).  
 ∅ 80 x 37 mm  
 PDP - 035 mm

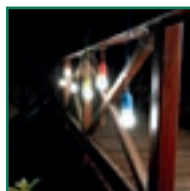

**LED LIGHTY • 94750**

Portable ABS and PP lamp with LED and 1.090 mm cord. Includes 3 AAA batteries.  
 ∅ 55 x 160 mm  
 PDP - 15 x 40 mm

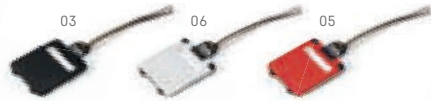

**FANNY • 98112**

ID tag, ideal for suitcases.  
 55 x 74 x 3 mm  
 PDP - 30 x 45 mm

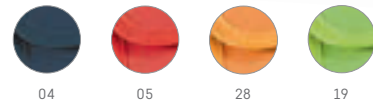

**AIRLINE • 92132**

600D travel document bag with 2 interior compartments and identification window.  
 275 x 140 mm  
 TRS - 120 x 60 mm



**EMIL • 98111**

Aluminum ID tag. Ideal for suitcases.  
 80 x 42 x 2 mm  
 LSR - 60 x 15 mm

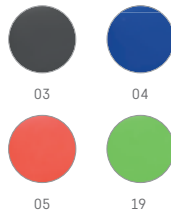

**SIVAN • 98123**

PVC ID tag, ideal for suitcases.  
 248 x 38 mm  
 SCR - 70 x 20 mm



**FINDO • 98124**

PP ID tag, ideal for suitcases.  
 87 x 50 x 4 mm  
 PDP - 50 x 20 mm





27



**CLAVIS • 98125**

Metal lock with numerical combination.

- ▮ 36 x 38 x 9 mm
- ▮ LSR - 10 x 23 mm



06

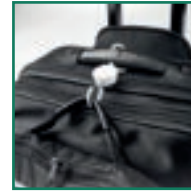

**OREN • 23200**

Hook with carabiner.

- ▮ 44 x 130 x 18 mm
- ▮ PDP - Ø33 mm



19



**NEVADA • 71023**

Textile strap for travel trolley.

- ▮ 50 x 1730 mm
- ▮ DGL - 50 x 90 mm



03



06



**CHECKIN • 97388**

Mini digital ABS scale for a maximum weight of 40kg. Ideal for suitcases. Includes 1 CR2032 battery.

- ▮ 37 x 100 x 27 mm
- ▮ PDP - 15 x 15 mm



06

**BILBO** • 94879

Travel sewing set supplied in case.

⊞ 70 x 21 x 65 mm

✂ STI - 50 x 25 mm



08

**TROYE** • 98114

PU foam earplugs. These plugs are not personal protective equipment. Product supplied in PVC box.

⊞ Ø14 x 26 mm | Box: 35 x 35 x 15 mm

✂ SCR - 16 x 16 mm



24

**HARPER** • 94855

PP toothbrush with protective cover.

⊞ Closed: 111 x 21 x 15 mm

✂ PDP - 50 x 10 mm



03

**DOZY** • 98113

Practical 190T sleeping mask with padded interior.

⊞ 185 x 90 mm

✂ TRS - 100 x 35 mm



**STRADA • 98180**

Neck pillow supplied in a pouch.  
 ☰ Empty: 425 x 275 mm | Pouch: 175 x 115 mm  
 ⚡ SCR - 100 x 25 mm



**TRAVELX • 98177**

Practical travel set including neck cushion, sleep mask, earplugs (not personal protective equipment) and 1 pair of socks. Supplied with 190T pouch.  
 ☰ Pouch: 150 x 200 mm  
 ⚡ TRS - 100 x 100 mm

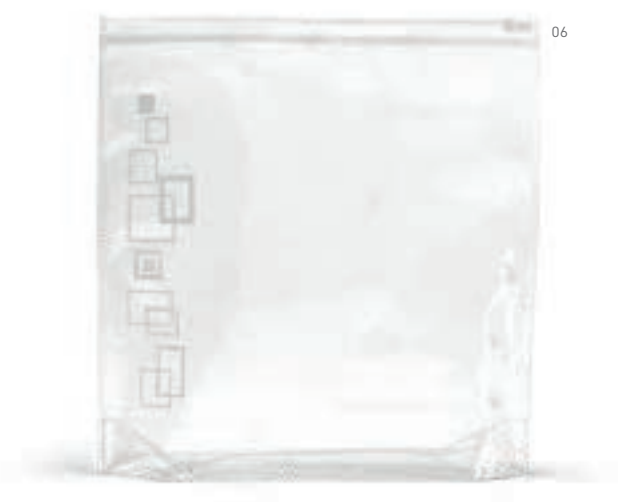

**VALENTINA • 92720**

Airtight PVC cosmetic bag. Suitable for traveling by plane. Bottles not included.  
 ☰ 165 x 185 x 40 mm | Capacity < 1 Liter  
 ⚡ SCR - 110 x 110 mm



**DENIRO • 92722**

Airtight PVC cosmetic bag that includes 3 bottles (2 x 65 ml and 1 x 60 ml), 1 vaporizer (80 ml) and 1 funnel. Ideal for traveling by plane.  
 ☰ 190 x 155 x 40 mm  
 ⚡ SCR - 120 x 100 mm



### COBB • 98117

6-piece shoe cleaning case.

∅ 98 x 56 mm  
 LSR - 65 x 65 mm



### RENAU • 98108

PS shoehorn.

153 x 38 mm  
 PDP - 50 x 15 mm



### GWENNO • 92851

Non-woven shoe bag (80 g/m<sup>2</sup>).

360 x 420 mm  
 TRS - 230 x 280 mm



### VANCE • 71025

Sticky lint roller

∅ 25 x 117 mm  
 PDP - 12 x 50 mm





03

**FONTAINE • 98196**

Non-woven suit holder (70 g/m²).

▮ 600 x 1000 mm

✂ TRS - 100 x 150 mm



03

**SEVENTH • 98171**

Non-woven suit holder (80 g/m²).

▮ 650 x 1090 mm

✂ TRS - 100 x 200 mm



**LAURIEN • 98126**

Parking disc with ice scraper.

- ▮ 118 x 7 x 155 mm
- ♣ STI - 90 x 35 mm

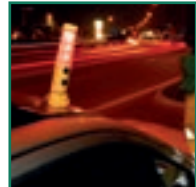

**FLASHMER • 94759**

Emergency hammer with magnet, car seat belt cutter and flash light with 1 white LED and 3 red LEDs. Includes 2 AA batteries. This product supplied in a box.

- ▮ Ø38 x 193 mm
- ♣ PDP - 15 x 50 mm



**SOLDEU • 98122**

Ice scraper with glove.

- ▮ 165 x 270 x 13 mm
- ♣ PDP - 7 x 50 mm



**ENCAMP • 98181**

Translucent plastic ice scraper.

- ▮ 108 x 224 mm
- ♣ PDP - 40 x 50 mm



**TARTER • 98182**

Useful ice scraper.

- ▮ 109 x 120 x 3 mm
- ♣ PDP - 20 x 40 mm





07



**SUNSHADE • 98191**

PE foam car sunshade lined and with 1 aluminum foil. This sunshade is suitable for front glass and includes 2 suction cups.

▮ 1300 x 600 mm  
 ↗ TXP - 550 x 300 mm



07



**GUARDSUN • 98192**

PE bubble car sunshade lined with aluminium foil on front and back. This sunshade is suitable for front glass and includes 2 suction cups.

▮ 1300 x 600 mm  
 ↗ TXP - 550 x 300 mm



05



**AMIGO • 98184**

Plastic ice scraper with brush.

▮ 400 x 70 x 100 mm  
 ↗ STI - 40 x 20 mm

05

14



03



**DIG • 94760**

Metal foldable shovel with compass and rubber handle, supplied in 600D pouch.

▮ Folded: 160 x 100 mm | Open: 420 x 100 mm  
 ↗ TRS - 70 x 60 mm





**JOHAN • 98081**

Deck of 54 cards in laminated paper and supplied in plastic box.  
 100 x 70 x 20 mm  
 PDP - 50 x 20 mm



**CARTES • 98080**

Deck of 54 cards in laminated paper and supplied in a paper box.  
 89 x 59 x 17 mm  
 SCR - 70 x 45 mm



**MIKA • 98006**

Mikado game in wooden box.  
 193 x 45 x 26 mm  
 LSR - 100 x 20 mm



**MIGUEL • 98004**

Domino game in wooden box.  
 146 x 50 x 30 mm  
 LSR - 100 x 30 mm



**EDDY • 98089**

Poker game in aluminum box with 2 decks of cards and 4 x 25 chips (blue, green, white and red).  
 192 x 117 x 50 mm  
 LSR - 170 x 100 mm



**PITCH • 98023**

2 in 1 game set in wooden box.  
Includes deck of cards and dice.

- ▮ 103 x 97 x 25 mm
- ♣ LSR - 60 x 60 mm

**PLAYTIME • 98001**

Family game set: 4 in 1. This wooden box includes: domino, mikado, a deck of cards and dice.

- ▮ 190 x 138 x 31 mm
- ♣ LSR - 150 x 100 mm



**BALADE • 94751**

LED

ABS dog dispenser with LED, carabiner clip and includes 20 plastic bags. This product includes 3 LR1130 batteries.

Dispenser: Ø40 x 100 mm | Bags: 265 x 310 mm  
 PDP - 10 x 45 mm



**TROTTE • 95103**

Bone-shaped PP bag dispenser including 20 PE bags

Closed: 111 x 21 x 15 mm  
 PDP - 30 x 15 mm





DW



**HYGGE • 94678**



Double-walled stainless steel travel cup.  
Capacity up to 400 ml. Supplied in a box.



∅ 88 x 112 mm  
LSR - 30 x 50 mm



**RONDE • 94677**



Double-walled stainless steel travel cup.  
Capacity up to 400 ml. Supplied in a box.



∅ 88 mm x 112 mm  
LSR - 30 x 50 mm



**EXPRESS • 94634**



Stainless steel PP travel cup with double body, lid and non-slip base. The cup has a capacity up to 310 ml.



∅ 73 x 144 mm  
LSR - 40 x 100 mm



07



**DURANT • 94609**



Thermos flask and mugs in stainless steel. Set includes 2 mugs, double body bottle and 600D pouch. The thermos has a capacity of up to 500 ml and the mugs have a capacity of up to 200 ml.

☒ Pouch: 155 x 250 x 90 mm  
 ✂ LSR - 15 x 150 mm



47

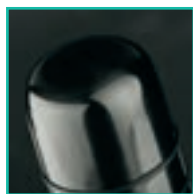

750ml



**HEAT • 94667**



Stainless steel thermos flask with 2 cups and capacity up to 750 ml. This product is supplied in a box.

☒ Ø86 x 310 mm  
 ✂ SCR - 70 x 120 mm





### NATUREL • 94683



Bamboo and stainless steel thermal bottle with double body and tea infuser. This bottle has a capacity up to 430 ml and is supplied in a gift box.



∅ 69 x 207 mm | Box: 72 x 210 x 72 mm  
LSR - 20 x 130 mm



DW



06

03



### SAFE • 94680



Stainless steel and PP thermal bottle with double body and cup. Capacity up to 490 ml. Supplied in box.



∅ 68 x 247 mm  
LSR - 20 x 100 mm



### INGRAM • 94682



Stainless steel thermal bottle with double body and tea infuser. Capacity up to 470 ml. Supplied in gift box.



∅ 65 x 230 mm | Box: 74 x 235 x 74 mm  
LSR - 20 x 150 mm







### LITER • 94679



1000 ml stainless steel thermos flask.  
This flask is supplied in a box.



∅ 82 x 330 mm  
LSR - 70 x 120 mm



### ETHAN • 54388



Stainless steel thermos flask with  
capacity up to 750 ml.



∅ 81 x 290 mm  
LSR - 30 x 80 mm



### KARPOV • 94610



Stainless steel thermos flask with double body and  
capacity up to 500 ml. Supplied in box.



∅ 67 x 240 mm  
LSR - 15 x 150 mm



### LUKA • 94615



Stainless steel thermos flask with double body and  
capacity up to 500 ml. Supplied in box.



∅ 69 x 238 mm  
LSR - 20 x 100 mm





**HASSI • 94676**



Double-walled stainless steel travel cup. Capacity up to 510 ml. Supplied in a box.



∅ 87 mm x 151 mm  
 LSR - 25 x 30 mm



03



03



06



**MONARDA • 94681**



Stainless steel and PP travel cup with double body, lid with anti-spill system and non-slip at the base. The cup has a capacity up to 470 ml and comes in a gift box.



∅ 80 x 198 mm | Box: 82 x 202 x 82 mm  
 LSR - 20 x 70 mm



03



**JAMIE • 94675**



Stainless steel double-walled cup with lid, non-slip silicone and with capacity up to 410 ml. This product is supplied in a box.



∅ 84 x 153 mm  
 LSR - 20 x 30 mm



**BATUM • 94625**



Stainless steel and PP travel cup with double body and lid. Holds up to 420 ml. Supplied in box.



∅ 81 x 167 mm  
LSR - 25 x 30 mm



**WINGS • 94614**



Stainless steel mug with carabiner and capacity up to 230 ml.



∅ 70 x 82 mm  
LSR - 25 x 60 mm



**NOAH • 94608**



Stainless steel and PP travel mug with lid and capacity up to 420 ml. Supplied in box.



∅ 80 x 170 mm  
LSR - 25 x 30 mm



**LIVE • 94607**



PP travel mug with lid and capacity up to 420 ml. Supplied in a box.



∅ 80 x 170 mm  
PDP - 20 x 35 mm



**RAJANI • 94698**



Stainless steel travel mug with lid and 450 ml capacity. This product is supplied in a box.



∅85 x 145 mm



**MINT • 94640**



Stainless steel and PP travel cup with double body, lid and non-slip base. This cup has capacity up to 520 ml and is supplied in a box.



∅84 x 190 mm  
LSR - 25 x 30 mm



**LARRY • 94641**



Stainless steel and PP travel cup with double body, lid and non-slip base. This cup has capacity up to 520 ml and is supplied in a box.



∅72 x 184 mm  
LSR - 25 x 30 mm



03



05



14



**WERNER • 94666**



PP and PS double-walled travel mug with capacity up to 520 ml.

∅ 86 x 168 mm

➤ DGL - 136 x 220 mm



**GASOL • 94617**



PP travel cup with double body and lid. Capacity up to 450 ml.

∅ 85 x 170 mm

➤ SCR - 40 x 80 mm



05



14

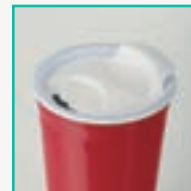

**GOBLET • 54506**



Double-walled travel cup with lid and capacity up to 500 ml.

∅ 100 x 160 mm

➤ PDP - 30 x 30 mm



**LILARD • 94639**



PP travel cup with double body and lid.  
Capacity up to 510 ml.



∅ 75 x 221 mm



∠ PDP - 30 x 40 mm



**LANDSCAPE • 94601**



Aluminum sports bottle with carabiner  
and capacity up to 400 ml.

∅ 66 x 176 mm

∠ LSR - 35 x 100 mm



**SPORTY • 94633**





Aluminum sports bottle with carabiner.  
Capacity up to 800 ml.

∅ 73 x 259 mm



∠ LSR - 25 x 150 mm







 **KORVER • 94631**  
 Aluminum and AS sports bottle with capacity up to 650 ml.  
 ∅ 66 x 250 mm  
 LSR - 20 x 120 mm



 **LEMON • 94649**  
 Aluminum and PP sports bottle with capacity up to 670 ml.  
 ∅ 73 x 217 mm  
 LSR - 25 x 120 mm



 **SERENA • 94618**  
 Stainless steel and AS sports bottle with capacity up to 600 ml.  
 ∅ 71 x 215 mm  
 LSR - 10 x 25 mm



**SHOW • 94550**



Double-walled stainless steel sports bottle with lid.  
This bottle has a capacity up to 510 ml and is supplied  
in a cardboard box.



∅67 x 255 mm  
LSR - 100 x 20 mm





# BOROSILICATE GLASS

DW



**DHABI • 94668**



Borosilicate glass bottle with PP lid. This bottle has a silicone protection. It has a capacity up to 380 ml. Supplied in a box.

∅ 58 x 191 mm

DOM - 20 x 20 mm



**WILLIAMS • 94669**



Borosilicate glass bottle with PP screw lid. This bottle has a matte gradient finish and a silicone handle. It has a capacity up to 470 ml and is supplied in a cardboard box.

∅ 60 x 210 mm

PDP - 25 x 50 mm

# RESISTANT TO DIFFERENT TEMPERATURES



**DAKAR • 94699**



Borosilicate glass bottle with bamboo lid and silicone pouch. This bottle has a capacity up to 600 ml and is supplied in a cardboard box.

∅ 68 x 231 mm

PDP - 25 x 30 mm



DW



HOT



COLD



**RAISE • 94646**

Glass and stainless steel sports bottle with a capacity of up to 520 ml. Supplied with soft shell sleeve.

∅ 65 x 225 mm  
 TRS - 55 x 90 mm



**STRAW • 94070**

550 ml glass mug with straw.

∅ 81x140 mm  
 PDP - 30 x 30 mm





 **DUDLEY • 94628 tritan™**  
 Tritan™ sports bottle with flexible straw cap (inside). This bottle has smartphone holder and capacity up to 750 ml.  
 ∅ 75 x 222 mm  
 SCR - 100 x 150 mm

 **PEPE • 54620 tritan™**  
 Easy-open Tritan™ sports bottle with compartment for cards. This bottle has capacity up to 800 ml and is supplied in a box.  
 ∅ 80 x 260 mm  
 SCR - 70 x 70 mm



MORE THAN  
1L CAPACITY



**RAMON** • 94643



PETG sports bottle with push-pull mouthpiece with a capacity of up to 1,250 ml.

∅ 110 x 230 mm

STI - 40 x 70 mm



**CLOUDS** • 94632



PS and ABS sports bottle with push-pull mouthpiece and vaporizer. Capacity up to 600 ml.

∅ 66 x 250 mm

SCR - 70 x 170 mm



**ROZIER • 94648 tritan™**

Tritan™ sports bottle with screw cap and capacity up to 790 ml.

∅ 71 x 246 mm  
SCR - 100 x 140 mm



**JIM • 94663 tritan™**

Tritan™ sports bottle with capacity up to 510 ml.

∅ 68 x 203 mm  
SCR - 70 x 140 mm



**TOWN • 54629**

AS and PP sports bottle with fruit infuser inside. It has capacity up to 740 ml. Supplied in box.

∅ 70 x 247 mm  
SCR - 100 x 100 mm





**GILDED • 94690**



PE foldable bottle with capacity up to 460 ml.

∓ 110 x 218 x 64 mm

✂ SCR - 75 x 60 mm



**KWILL • 94612**



PE foldable bottle with capacity up to 460 ml.

∓ 110 x 218 x 64 mm

✂ SCR - 60 x 70 mm



**LOWRY • 94616**



HDPE sports bottle with push-pull mouthpiece and capacity up to 530 ml.

∓ Ø67 x 191 mm

✂ SCR - 60 x 80 mm

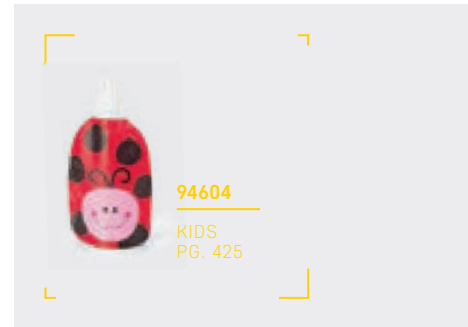



**ODRET • 94622**

AS sports bottle with cap with flexible mouthpiece (inside). Convenient and easy to open and holds up to 650 ml.

∅ 73 x 214 mm  
 SCR - 50 x 70 mm



03



14



05



28



19



28



**PORTIS • 94630**

PP and PS sports bottle. Capacity up to 600 ml.

∅ 67 x 245 mm  
 SCR - 100 x 120 mm



03



05



14



**CONLEY • 94621**

PS and PE sports bottle with flexible straw cap (inside). Capacity up to 500 ml.

∅ 70 x 230 mm  
 SCR - 60 x 150 mm





14



19



03

14

05

19



**CINNAMON • 94626**



Bamboo fiber, rice hull and melamine travel cup. This cup holds up to 450 ml and contains silicone band and lid.



∅ 96 x 140 mm



LSR - 25 x 30 mm



14

28

24

19



**CANNA • 94638**



Bamboo fiber PP travel cup with silicone band and lid. This cup has capacity up to 500 ml.



∅ 95 x 140 mm



LSR - 20 x 25 mm



50



19

08

24

50



**PETRELLI • 94637**



Rice fiber and PP cup with capacity up to 400 ml.



∅ 88 x 102 mm



PDP - 20 x 50 mm



**94097**

HOME  
PG. 329



**94091**

HOME  
PG. 329



24

19

04

08



08

**BACURI • 94691**

Bamboo fiber PP travel cup. This cup has capacity up to 450 ml.



∅ 93 x 134 mm  
PDP - 20 x 40 mm

**TISANA • 94636**

Bamboo fiber and PP travel cup with capacity up to 450 ml and with lid.



∅ 93 x 134 mm  
PDP - 25 x 40 mm



50



06

**PRESSO • 94674**

100 ml porcelain cup with saucer. This product is supplied in a box.

☿ Cup: Ø63 x 49 mm | Saucer: Ø118x20 mm |

☿ Box: 122 x 122 x 66 mm

☿ FIR - 40 x 30 mm



10

**EXPRESSO • 93873**

Glass coffee set. This set includes 2 double-body isothermal cups with a capacity of up to 90 ml. This product is supplied in a gift box.

☿ Box: 133 x 65 x 65 mm

☿ PDP - 25 x 10 mm



10

**MACHIATO • 93895**

Set of 2 double insulated isothermal glass cups. The cups have a capacity of up to 350 ml and the set is supplied in a gift box.

☿ Box: 195 x 125 x 95 mm

☿ PDP - 25 x 20 mm



93996

HOME  
PG. 322



93995

HOME  
PG. 32



**DUWAL • 94692**



Double-body porcelain cup with silicone cap, with capacity up to 280 ml and supplied in a box.

∅ 86 x 122 mm  
PDP - 25 x 25 mm



06



06



**INFUSIONS • 93869**



Porcelain tea set. This set has a 260 ml teapot and a 430 ml cup. This product is supplied in a box.

∅ 147 x 113 x 143 mm  
PDP - 35 x 15 mm



**COLE • 93805**



2 in 1 ceramic tea set - 430 ml teapot with stainless steel strainer and 260 ml mug.

∅ 113 x 140 mm  
PDP - 20 x 30 mm



**LAFFANI • 93896**



Ceramic mug with metallic finish and capacity up to 350 ml. This mug is supplied and not suitable for microwaves.

∅ 82 x 96 mm | Box: 102 x 117 x 88 mm

SCR - 70 x 150 mm



**FRANZ • 94052**



Porcelain mug with capacity up to 650 ml.

∅ 98 x 144 mm

FIR - 65 x 90 mm



**LISETTA • 94047**



Ceramic mug with capacity up to 310 ml. This mug is supplied in a box.

∅ 88 x 96 mm | Box: 112 x 89 x 102 mm

PDP - 30 x 30 mm



DW



**MOCHA • 93897**



Ceramic mug. This mug is ideal for sublimation, holds up to 350 ml and is supplied in a box.

∅ 82 x 95 mm | Box: 102 x 117 x 88 mm  
 SUB - 80 x 180 mm



**ANISEED • 93990**



Ceramic mug. This mug is ideal for sublimation, holds up to 350 ml and comes in a gift box.

∅ 83 x 98 mm | Box: 100 x 118 x 86 mm  
 SUB - 80 x 180 mm



Cold liquid



Hot liquid



**SUBLIM • 94049**



Ceramic mug with capacity up to 370 ml. Suitable for all-round sublimation printing.

∅ 83 x 97 mm  
 SUB - 200 x 85 mm



**WOW • 93843**



Thermosensitive glaze ceramic mug with capacity up to 350 ml. This mug is suitable for sublimation all around. The printing will appear, after the mug has a hot drink inside. This product is supplied in a box.

∅ 83 x 97 mm | Box: 120 x 88 x 102 mm  
 SUB - 85 x 200 mm



06



**MATCHA • 93888**



Porcelain mug with capacity up to 350 ml and supplied in box.

∓ Ø82 x 100 mm | Box: 115 x 120 x 90 mm

↗ PDP - 25 x 30 mm



24



**CINANDER • 93832**



Ceramic mug with capacity up to 370 ml and supplied in box.

∓ Ø84 x 103 mm | Box: 90 x 120 x 87 mm

↗ PDP - 25 x 25 mm



06



**PANTHONY OWN • 94046**



Porcelain mug with capacity up to 450 ml. This product is supplied in a box.

∓ Ø95 x 100 mm | Box: 130 x 101 x 107 mm

↗ PDP - 20 x 35 mm



28



**ROYCE • 94054**



Porcelain mug with capacity up to 440 ml.

∓ Ø98 x 100 mm

↗ FIR - 60 x 50 mm



DW



02



**PANTHONY** • 94044 **MADE IN EUROPE**



Porcelain mug with hydroglaze. Capacity up to 450 ml. Supplied in a box.

∅ 95 x 100 mm | Box: 130 x 101 x 107 mm

PDP - 20 x 35 mm



14



**PANTHONY MAT** • 94045 **MADE IN EUROPE**



Porcelain mug with hydroglaze. Capacity up to 450 ml. Supplied in a box.

∅ 95 x 100 mm | Box: 130 x 101 x 107 mm

PDP - 20 x 35 mm





**COLBY • 93837**

Ceramic mug with capacity up to 350 ml.  
This mug is supplied in a box.

∅ 90 x 104 mm  
PDP - 20 x 25 mm



**NELS WHITE • 94693**

Porcelain mug with capacity up to 320 ml.  
This product is supplied in a box.

∅ 81 x 98 mm | Box: 96 x 86 x 105 mm  
PDP - 30 x 40 mm



**NELS • 94671**

Porcelain mug with capacity up to 320 ml.  
This product is supplied in a box.

∅ 81 x 98 mm | Box: 96 x 86 x 105 mm  
SRC - 55 x 155 mm



06



**AVOINE • 93834**

Ceramic mug with capacity up to 370 ml and supplied in box.

∅ 90 x 85 mm | Box: 111 x 115 x 87 mm  
 PDP - 240 x 65 mm



03

13

34

24

44

05

28

08

31

19

09



19

DW



**COMANDER • 93833**

Ceramic mug with capacity up to 370 ml and supplied in box.

∅ 90 x 85 mm | Box: 111 x 115 x 87 mm  
 PDP - 30 x 30 mm



06



**VERNON WHITE • 94673**

Ceramic mug with capacity of 360 ml and supplied in a box.

∅ 88 x 84 mm | Box: 112 x 94 x 91 mm  
 PDP - 30 x 30 mm



34

05

08

19



08



**VERNON • 93836**

Ceramic mug with capacity up to 360 ml. This mug is supplied in a box.

∅ 88 x 84 mm | Box: 112 x 94 x 91 mm  
 PDP - 30 x 30 mm

**BARINE • 93887**

Porcelain mug with a capacity of up to 350 ml and supplied in a box.

∅ 82 x 97 mm | Box: 102 x 117 x 88 mm

✂ SCR - 70 x 150 mm

**NAIPERS • 93855**

Ceramic mug with a capacity of up to 260 ml and is supplied in a box.

∅ 74 x 84 mm | Box: 88 x 100 x 78 mm

✂ SCR - 55 x 140 mm

**CURCUM • 93937**

Ceramic mug with capacity up to 350 ml and supplied in gift box.

∅ 83 x 98 mm | Box: 100 x 118 x 86 mm

✂ SCR - 70 x 150 mm



06



**MOCCA WHITE • 94672**

Ceramic mug with capacity of 270 ml and supplied in a box.

∅ 82 x 86 mm | Box: 97 x 85 x 91 mm  
 SRC - 50 x 80 mm



04

05

05

13



**MOCCA • 93806**

Ceramic mug with capacity of 270 ml and supplied in a box.

∅ 82 x 86 mm | Box: 97 x 85 x 91 mm  
 SRC - 50 x 80 mm



05

05

06

24



**CHALKIE • 93957**

Mug. Ceramic. Matt finish. Capacity up to 350 ml. Supplied in box. Chalk included.

∅ 81 x 96 mm | Box: 102 x 118 x 88 mm  
 SRC - 50 x 155 mm



28

24

02

19



02



**LYNCH • 93886**

Ceramic mug with neon matt finish, holds up to 350 ml and is supplied in a box. The exterior finish of this mug reactivates the effect of the slate and lets you write on it with chalk (not included).

∅ 83 x 97 mm | Box: 102 x 117 x 88 mm  
 SCR - 70 x 150 mm



### SOFFY • 94024

Glass mug with a smile on the base, with capacity up to 280 ml and supplied in a box.

∅ 79 x 81 mm  
PDP - 20 x 30 mm



### KENNY II • 93804

Frosted glass mug with 340 ml capacity and supplied in a box.

∅ 80 x 97 mm | Box: 120 x 88 x 102 mm  
PDP - 35 x 40 mm



### LATTE • 93842

Mug, Glass. Capacity up to 230 ml. Supplied in box.

∅ 71 x 100 mm | Box: 100 x 78 x 105 mm  
FIR - 50 x 60 mm



DW



10



**BORDEAUX • 94023**

**MADE IN EUROPE**

Wine glass set with a 1600 ml bottle and two 450 ml glasses. Supplied in box.

Box: 285 x 196 x 200 mm

SND - 60 x 30 mm



07

**NOVAK • 94665**

Set of stainless steel hip flask volume 200 ml, funnel and cups volume 4x 20 ml in gift box.



⊠ 189 x 40 x 168 mm  
 ↗ LSR - 80 x 50 mm



07

**MUSE • 94684**

Stainless steel pocket bottle with capacity up to 180 ml. This bottle is supplied in a box.

⊠ 100 x 110 x 25 mm  
 ↗ LSR - 50 x 80 mm



07

**HIMALAYAS • 94664**

Set of 4 stainless steel cups with imitation leather pouch and with capacity up to 25 ml. This set is supplied in a gift box.



⊠ Ø44 x 62 mm | Box: 45 x 66 x 45 mm  
 ↗ LSR - 15 x 20 mm







03



### FLARE • 54142

Kit of 5 pieces of barbecue in wood and stainless steel and a bamboo board. The 5-piece barbecue set is supplied in a 210D hard case.

Tray: 303 x 200 x 12 mm | Bag: 350 x 230 x 40 mm  
 LSR - 190 x 140 mm



03



### GRILL • 54145

3-piece wood and stainless steel barbecue kit that is supplied in a 210D hard case.

Bag: 350 x 230 x 40 mm  
 TRS - 280 x 60 mm





**SALSA • 54139**  
 Two-piece stainless steel and bamboo barbecue kit. This kit is supplied in craft box.  
 Box: 340 x 115 x 25 mm  
 LSR - 30 x 10 mm



**SOARES • 93998**  
 Barbecue set with 3 pieces in stainless steel. This set is supplied in a non-woven bag.  
 Bag: 405 x 120 x 25 mm  
 LSR - 80 x 7 mm



**LERY • 94039**  
 Set with 3 foldable pieces: a stainless steel spoon, fork and knife. This set is supplied in a 600D pouch.  
 Folded: 92 mm | Open: 165 mm | Bag: 80 x 110 mm  
 TRS - 50 x 50 mm



**CREARY • 93891**  
 Set of 4 stainless steel and wooden knives. This set is supplied in a gift box.  
 Box: 225 x 118 x 21 mm  
 LSR - 40 x 7 mm



60

HO



**MALVIA • 93975**



Bamboo cheese board with knife included.  
This product is supplied in a craft box.

300 x 260 x 15 mm | Box: 307 x 267 x 21 mm  
LSR - 150 x 50 mm



60



**WOODS • 93830**



Bamboo cheese board with 2 bamboo and stainless steel accessories. This customisable cheese board is supplied in a cardboard box.



310 x 180 x 15 mm | Box: 316 x 186 x 25 mm  
LSR - 70 x 70 mm



HO



60



**SESAME • 93831**



Bamboo board. This board is ideal for serving snacks and is supplied in cardboard sleeve.

▮ 420 x 134 x 7 mm | Sleeve: 260 x 135 x 10 mm

♣ LSR - 70 x 70 mm



60



**CAPERS • 93966**



Bamboo cheese board.

▮ 200 x 143 x 9 mm

♣ LSR - 140 x 120 mm



60



**BANON • 93880**



Bamboo cheese board.

▮ 300 x 200 x 9 mm

♣ LSR - 200 x 180 mm



**FABRIS • 93829**



Bamboo plate with cup holder. This plate that is ideal for serving appetizers is supplied in cardboard sleeve.

▮ 200 x 147 x 13 mm | Sleeve: 160 x 148 x 14 mm  
 ⚡ LSR - 100 x 10 mm

60



HO



**PAPRIKA • 93898**



Bamboo appetiser set with 2 silicone cups. This product is supplied in a craft box.

▮ Bowls: 87 x 87 x 50 mm | Base: 347 x 168 x 19 mm |  
 Box: 355 x 175 x 30 mm  
 ⚡ LSR - 110 x 150 mm

00



00



**PICKLED • 93885**



Bamboo cheese board.

▮ Bowls: 87 x 87 x 50 mm | Base: 300 x 105 x 9 mm |  
 Box: 310 x 110 x 28 mm  
 ⚡ LSR - 230 x 15 mm





60

 **MUSTARD • 93861**  
 Bamboo serving tray supplied in craft box.  
 ⚓ 255 x 130 x 18 mm | Box: 260 x 134 x 26 mm  
 ⚡ LSR - 100 x 30 mm



10

 **CHARLES • 93875**  
 Glass cruet containing two compartments with capacity up to 50 ml and up to 250 ml. This cruet contains two cork stoppers and is supplied in a gift box.  
 ⚓ Box: 75 x 175 x 75 mm  
 ⚡ DGL - 60 x 40 mm





27

 **SMARTPEPPER • 93989**  
 Stainless steel salt and pepper grinder.  
 ⚓ Ø27 x 153 mm  
 ⚡ LSR - 8 x 30 mm



60

 **CUMARI • 93889**  
 Bamboo pepper or salt grinder. This product is supplied in a box.  
 ⚓ Ø52 x 155 mm | Box: 61 x 61 x 165 mm  
 ⚡ PDP - 15 x 25 mm



**SALVY • 93969**



Set of 2 bamboo salad cutlery.

▮ 300 x 60 mm

▮ LSR - 110 x 10 mm



**PEPPER • 93968**



Rectangular bamboo salad bowl.

▮ 214 x 214 x 70 mm

▮ LSR - 100 x 30 mm

# ENJOY THE OLDEST EUROPEAN TEA.

## OFFERING GORREANA IS OFFERING HISTORY WITH AROMA.

Founded in 1883 and located in Azores, the Gorreana tea factory is the oldest in Europe. The same family has been managing the planting area of 45 hectares for about 5 generations.

Gorreana teas represent a union of taste, health and ecology.

Gorreana teas have worldwide recognition and are ranked as some of the best and purest teas in the world.

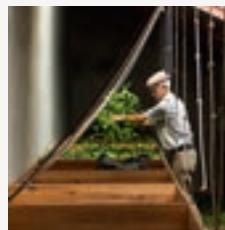

## BLACK TEA

The black tea Pekoe has a very strong and aromatic flavor. It is produced from the plant's second bearing bud. Due to the strong oxidation of *Camelia Sinensis* leaves, this tea displays a reddish and dark color and it also contains antioxidants, neuro-stimulants and caffeine.

## GREEN TEA

The spraying process of *Camellia Sinensis* leaves enhances its light and delicate aroma. This tea has great anti-oxidant and slimming effects, anti-cancer properties and in anti-aging.



### ARNICA • 93996



Bamboo tea box with 4 compartments and magnet closure. This tea box includes 40 tea bags of "Gorreana" Azorean tea (black and green) and is supplied in a craft box.

160 x 160 x 78 mm | Kraft box: 166 x 166 x 85 mm  
LSR - 140 x 140 mm



### BURDOCK • 93995



Bamboo tea box with 4 compartments and magnet closure. This tea box includes 20 tea bags of "Gorreana" Azorean tea (black and green) and supplies in a craft box.

160 x 87 x 78 mm | Kraft box: 166 x 91 x 87 mm  
LSR - 140 x 70 mm





94023

DRINKWARE  
PG. 311



**SYRAH • 94189**

Bamboo and zinc wine set. This set includes corkscrew with sommelier knife, drip stopper, pourer with cap and stopper.

☿ 363 x 112 x 119 mm

♣ LSR - 190 x 90 mm



60

HO



60



**GAUTHIER • 93967**

Set of 4 bamboo coasters. This product is supplied in a craft box.

☿ 115 x 115 x 35 mm | Coaster: 100 x 100 x 6 mm |

Box: 119 x 121 x 56 mm

♣ LSR - 80 x 80 mm



60



**CABERNET • 94190**

Bamboo and zinc wine set. This set includes a corkscrew with sommelier knife, thermometer, stopper and drip stopper.

☿ 147 x 167 x 54 mm

♣ LSR - 120 x 140 mm



05

**MALENA • 94198**

Wine set with aluminum and ABS corkscrew with sommelier knife and aluminum and silicone vacuum stopper. Set supplied in paper gift box.

▮ 95 x 145 x 30 mm

♣ LSR - 6 x 35 mm



03



27

**VINET • 94197**

Wine set with three pieces: corkscrew; sommelier knife; metal collar. This set comes in a bottle-shaped gift case with rubber finish.

▮ Ø63 x 236 mm

♣ LSR - 30 x 7 mm

**BARREL • 94191**

Zinc wine set. This set includes a corkscrew with a sommelier knife, stopper and is supplied in a gift box.

▮ 103 x 133 x 28 mm

♣ SCR - 60 x 90 mm



60

HO



**MORETO • 94119**

Cork wine set. This set includes corkscrew with sommelier knife, choker, pourer with lid and stopper.

☒ Ø144 x 42 mm  
☒ LSR - Ø90 mm



60



**BORBA • 92819**

Cork bag for 1 bottle.  
☒ 100 x 330 x 100 mm  
☒ TRS - 60 x 80 mm



**DABNEY • 93858**

Digital stainless steel and ABS wine thermometer for Ø65-80 mm bottles and 1 LR1130 battery (included).

± 75 x 80 x 40 mm  
 ↗ LSR - 5 x 20 mm



**VERMENTINO • 93892**

ABS vacuum bottle stopper.

± Ø48 x 73 mm  
 ↗ PDP - 10 x 40 mm



**MACABEU • 94193**

190T nylon cooler sleeve.

± 326 x 230 mm  
 ↗ TRS - 140 x 25 mm



**WRAP • 94089**

Softshell thermal sleeve for bottles with self-retracting mechanism.

± Open: 234 x 5 x 87 mm  
 ↗ TRS - 140 x 70 mm



27

03



Inox

**MALBEC • 94117**

Metal corkscrew with decapsulator, sommelier knife and stainless steel spiral.

∓ 121 x 20 x 12 mm

↗ PDP - 30 x 5 mm



27



**TANAT • 94103**

Metal corkscrew, with decapsulator and sommelier knife.

∓ 110 x 25 x 10 mm

↗ LSR - 70 x 7 mm



03



Inox

**BOTLER • 94199**

4-function stainless steel and metal corkscrew.

∓ 136 x 40 x 20 mm

↗ LSR - 40 x 8 mm



60

**CARIN • 94114**

Wooden corkscrew with decapsulator and sommelier knife.

∓ 109 x 25 x 8 mm

↗ PDP - 50 x 7 mm



**HOLZ • 94134**

Metal bottle opener with wooden handle.

☒ 150 x 17 x 40 mm

☞ SCR - 60 x 12 mm



**FUNFAYE • 94116**

Coaster with bottle opener and non-slip sponge on the base.

☒ 82 x 82 x 4 mm

☞ SCR - 65 x 40 mm



**BARLEY • 94118**

Aluminum bottle opener.

☒ 39 x 83 x 4 mm

☞ PDP - 10 x 30 mm



**MALTE • 94115**

Bottle opener with magnet.

☒ 50 x 105 x 5 mm

☞ DGL - 25 x 60 mm

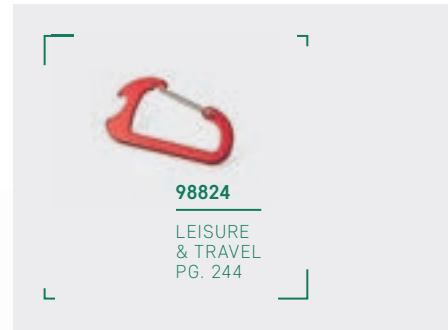



**Inox** **COCKTAIL • 94097**

Kit with reusable stainless steel straw and cleaning brush, supplied in a non-woven pouch (80g/m<sup>2</sup>).

☿ Straw: Ø6 x 215 mm | Pouch: 60 x 265 mm  
 ♣ LSR - 4 x 60 mm



HO

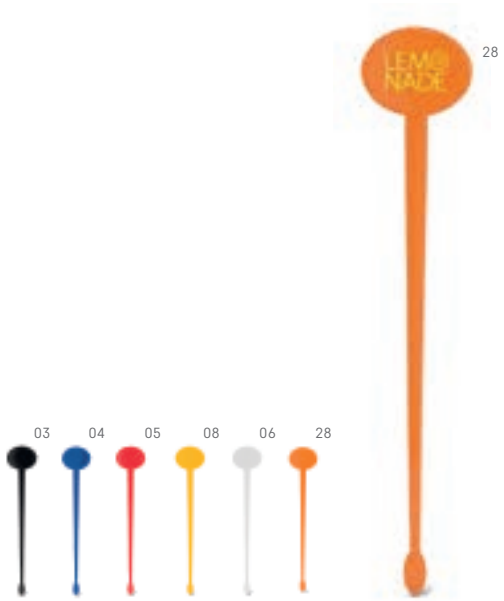

**BUCHANIO • 93971**

**MADE IN EUROPE**

PS cocktail stirrer.

☿ 35 x 180 mm

♣ PDP - 15 x 25 mm

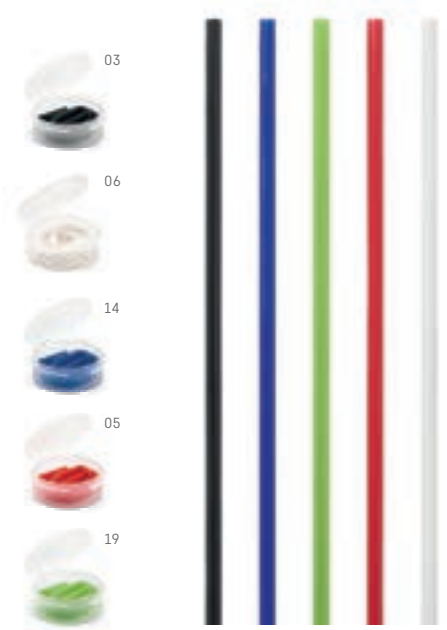

**DRINKY • 94091**

100% silicone reusable straw. This straw is supplied in a translucent white PP case with matte finish allowing it to be carried.

☿ Straw: Ø7 x 250 mm | Case: Ø55 x 20 mm

♣ SCR - Ø35 mm



**BAIRD • 92844**

Non-woven (80 g/m<sup>2</sup>) bag for 1 bottle.

☒ 100 x 330 x 100 mm

☞ TRS - 60 x 280 mm



**COLOMBIA • 94194**

PVC cooler bag for 1 bottle with 35 cm handles.

☒ 100 x 250 x 100 mm

☞ SCR - 20 x 60 mm



**COOLIT • 95373**

Cooler bag for 1 bottle of wine.

☒ 168 x 380 x 100 mm

☞ DGL - 50 x 90 mm





**GARCIA • 93827**

Square shaped coaster.

▮ 100 x 100 x 5 mm

✂ LSR - 80 x 80 mm



**PISANI • 93828**

Round cork coaster.

▮ Ø100 x 5 mm

✂ LSR - 60 x 60 mm



A4

**DANNY • 92053**

Imitation leather menu holder.

▮ 235 x 315 x 9 mm

✂ SCR - 180 x 250 mm

B6

**TRUFFLE • 92061**

Imitation leather bill holder with pen holder  
(pen not included).

▮ 125 x 181 x 7 mm

✂ SCR - 100 x 150 mm

**RHUBARB • 93866**

PP cutlery set including 3 cutlery: fork, knife and spoon.

⊥ 31 x 178 x 20 mm  
 ↗ PDP - 10 x 35 mm

**PARSLEY • 93871**

Set of 3 hermetic PP boxes with capacities up to 1160 ml, 560 ml and 230 ml.

⊥ 170 x 170 x 67 mm  
 ↗ SCR - 50 x 50 mm

**CITRIC • 93881**

PP citrus juicer.

⊥ 133 x 181 x 70 mm  
 ↗ PDP - 10 x 20 mm

**COOKERY • 93883**

Silicone and PP basting brush.

⊥ 173 x 32 mm  
 ↗ PDP - 30 x 10 mm

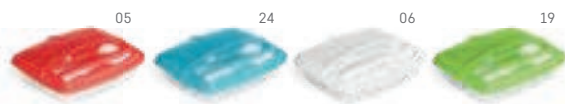

**MATTIE • 93857**  
 Airtight PP box with 3 compartments (250 ml, 270 ml and 470 ml). This box contains a fork and a knife. This box is suitable for microwave use (cover must be removed).  
 235 x 195 x 60 mm  
 PDP - 40 x 20 mm



**TOKEV • 93870**  
 Pizza cutter with bottle opener.  
 132 x 63 x 8 mm  
 PDP - 35 x 25 mm

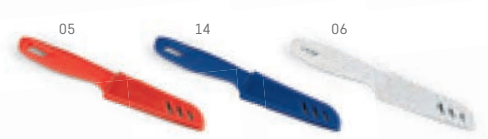

**MIKUS • 93872**  
 Stainless steel and PP knife with protective cover.  
 205 x 31 x 13 mm  
 PDP - 40 x 10 mm



**MONTIGNY • 97389**

ABS kitchen timer with rubber finish.

∅ 59 x 45 mm  
 DUV - 55 x 55 mm



**MONCO • 92836**

100% cotton bread bag.

220 x 560 mm  
 TRS - 150 x 280 mm



**ROSEMARY • 99831**

Cotton and polyester bar apron (150 g/m<sup>2</sup>) with 2 pockets.

900 x 480 mm | Pocket: 200 x 195 mm  
 TRS - 280 x 90 mm



**NAEKER • 99824**

Cotton and polyester bar apron (145 g/m<sup>2</sup>) with 2 pockets.

960 x 800 mm | Pocket: 145 x 200 mm  
 TRS - 200 x 130 mm



**CELERY • 99832**

Non-woven apron (80 g/m<sup>2</sup>) with 1 front pocket.

490 x 685 mm | Pocket: 230 x 175 mm  
 TRS - 200 x 200 mm



05



19



28



04



### CHIVES • 99822

Cotton and polyester adjustable apron (150 g/m<sup>2</sup>) with 2 front pockets.

▮ 650 x 900 mm |  
 Inner pocket: 80 x 140 mm |  
 Outer pocket: 250 x 160 mm  
 ✂ TRS - 200 x 230 mm

### CURRY • 99811

Cotton and polyester apron (180 g/m<sup>2</sup>).

▮ 650 x 900 mm  
 ✂ TRS - 240 x 280 mm

### CHILLI • 99800

100% cotton apron with 1 front pocket.

▮ 600 x 900 mm |  
 Pocket: 250 x 200 mm  
 ✂ TRS - 180 x 200 mm

### GINGER • 99830

Adjustable cotton and polyester apron (150 g/m<sup>2</sup>) with 2 frontal pockets.

▮ 650 x 850 mm |  
 Pocket: 170 x 180 mm  
 ✂ TRS - 200 x 230 mm



### THORPE • 99074

Polar fabric blanket (180 g/m<sup>2</sup>) and removable handle.

▮ 1500 x 1200 mm  
 ✂ TRS - 95 x 40 mm



### SULENA • 99051

Polar fabric blanket (180 g/m<sup>2</sup>).

▮ 1450 x 950 mm  
 ✂ TRS - 280 x 200 mm



### AUSTIN • 99072

Polar fabric blanket (250 g/m<sup>2</sup>) with satin ribbon and card for personalization.

▮ 1600 x 1300 mm | Cardboard: 160 x 140 mm  
 ✂ SCR - 100 x 100 mm



04

### WARMY • 99071

Polar fabric blanket (250 g/m<sup>2</sup>) with satin ribbon and card for personalization.

☒ 1600 x 1300 mm | Cardboard: 160 x 140 mm  
 ✂ TRS - 1500 x 200 mm



31



04

15

31

### DYLEAF • 99075

Polar fabric blanket (240 g/m<sup>2</sup>), with velvety finish and anti-pilling treatment. The blanket has a satin ribbon and card for customisation.

☒ 1500 x 1200 mm | Cardboard: 160 x 130 mm  
 ✂ SCR - 100 x 100 mm



50



LED

**DARWIN • 97390**

MDF clock. This clock contains calendar, alarm, thermometer and includes 4 AAA batteries, 1 CR2032 battery, USB cable and is supplied in a gift box.

☿ 150 x 70 x 44 mm | Box: 170 x 92 x 54 mm

✂ PDP - 50 x 25 mm



05

**SWEET • 95817**

Candle in glass support, heart-shaped.

☿ Box: 93 x 93 x 25 mm

✂ STI - 40 x 20 mm



27

**SCHMITT • 93959**

Aluminum photo frame with support for standing.

☿ 135 x 135 x 4 mm | Photo: 135 x 75 mm

✂ LSR - 125 x 25 mm



27

**GUILLE • 93958**

Aluminum photo frame with support for standing.

☿ 100 x 155 x 4 mm | Photo: 100 x 121 mm

✂ LSR - 12 x 90 mm







**FERIA • 92869**

100% cotton bag (180 g/m<sup>2</sup>)  
with 60 cm handles in cork.

☒ 450 x 400 x 105 mm

✂ TRS - 280 x 200 mm



**BETO • 92820**

100% cotton canvas bag (280 g/m<sup>2</sup>) with inside pocket  
and 65 cm handles.

☒ 450 x 380 x 105 mm

✂ TXP - 260 x 260 mm





### SHANTI • 92827

Jute shopping bag (360 g/m<sup>2</sup>) with laminated interior and short shoulder straps.

▮ 430 x 340 x 175 mm  
✂ TRS - 230 x 160 mm



### TIZZY • 92828

Jute shopping bag (360 g/m<sup>2</sup>) with laminated interior and 60 cm webbing handles.

▮ 445 x 385 x 165 mm  
✂ TRS - 270 x 200 mm



### BRAGA • 92823

Jute bag (240 gsm) with 65 cm handles and a front 100% cotton pocket (140 gsm).

▮ 370 x 410 x 100 mm | Pocket: 370 x 270 mm  
✂ TXP - 150 x 200 mm



#### MERCAT • 92882

100% cotton bag (160 g/m<sup>2</sup>) with imitation jute detail and 65 cm handles.

☒ 375 x 415 mm  
✂ TRS - 200 x 280 mm



#### SABLON • 92919

100% cotton drawstring bag (160 g/m<sup>2</sup>) with imitation jute detail and cotton string.

☒ 370 x 410 mm  
✂ TRS - 200 x 280 mm





### EDMONTON • 92822

100% cotton canvas bag (280 g/m<sup>2</sup>) with inside pocket and 65 cm handles.

⊥ 460 x 400 x 150 mm  
 ✂ TXP - 260 x 260 mm



### VILLE • 92824

100% cotton canvas bag (280 g/m<sup>2</sup>) with front pocket, inside zip pocket and 60 cm handles. This bag also contains a magnetic closure.

⊥ 530 x 380 x 170 mm  
 ✂ TRS - 150 x 120 mm



### ROMFORD • 92913

100% cotton drawstring bag (180 g/m<sup>2</sup>).

⊥ 350 x 430 mm  
 ✂ TRS - 200 x 250 mm



03



04



05

**RYNEK • 92920**

Cotton bag (40% recycled cotton) with 65 cm handles.

☞ 375 x 415 mm

✂ TRS - 200 x 280 mm



05

04

03

19

28



03



28



**BAZAR • 92879**

100% cotton bag (140 g/m<sup>2</sup>) with 65 cm webbing handles.

☞ 370 x 410 x 100 mm

✂ TRS - 200 x 280 mm



### WHARF • 92902

Cotton bag with 75 cm handles.

☒ 370 x 410 mm

✂ TRS - 200 x 280 mm



### REGENT • 92414

100% cotton bag with 75 cm handles.

☒ 370 x 410 mm

✂ TRS - 240 x 260 mm



### VICTORIA • 92415

100% cotton bag with 30 cm handles.

☒ 370 x 410 mm

✂ TRS - 200 x 280 mm





**KOLONAKI • 92826**

100% cotton bag (140 g/m<sup>2</sup>) with 60 cm handles.  
 375 x 415 mm  
 TXP - 260 x 260 mm



SH



**BONDI • 92821**

100% cotton bag (140 g/m<sup>2</sup>) with inside pocket and 60 cm handles.  
 375 x 415 mm  
 TRS - 200 x 280 mm







### HANOVER • 92456

Cotton drawstring bag.

☒ 370 x 410 mm

✂ TRS - 230 x 280 mm



### ILFORD • 92914

100% cotton drawstring bag.

☒ 370 x 410 mm

✂ TXP - 260 x 260 mm



SH



50



**ORLEANS • 92922**

100% cotton foldable bag (100 g/m<sup>2</sup>). This product is supplied unfolded.

370 x 400 mm

TXP - 160 x 220 mm



MADE IN EUROPE

**TAYLA** • 92877

Craft paper bag (115 g/m<sup>2</sup>) with twisted handle.

320 x 390 x 110 mm  
 TXP - 200 x 200 mm



MADE IN EUROPE

**ELLEN** • 92876

Craft paper bag (115 g/m<sup>2</sup>) with twisted handle.

240 x 310 x 90 mm  
 TXP - 160 x 180 mm



MADE IN EUROPE

**LEIA** • 92875

Craft paper bag (115 g/m<sup>2</sup>) with twisted handle.

180 x 240 x 80 mm  
 TXP - 70 x 120 mm



MADE IN EUROPE

**GRANT** • 92873

Craft paper bag (100 g/m<sup>2</sup>) with twisted handle.

320 x 390 x 110 mm  
 TXP - 200 x 200 mm



MADE IN EUROPE

**CABAZON** • 92872

Craft paper bag (90 g/m<sup>2</sup>) with twisted handle.

240 x 310 x 90 mm  
 TXP - 160 x 200 mm



MADE IN EUROPE

**CITADEL** • 92871

Craft paper bag (90 g/m<sup>2</sup>) with twisted handle.

180 x 240 x 80 mm  
 TXP - 70 x 120 mm



92878

92871

92873

92875

92877

92872



MADE IN EUROPE

**KIRA** • 92878Craft paper bag (115 g/m<sup>2</sup>) with twisted handle.

☒ 400 x 340 x 110 mm

✂ TXP - 200 x 200 mm



MADE IN EUROPE

**KELLY** • 92874Craft paper bag (100 g/m<sup>2</sup>) with twisted handle.

☒ 400 x 340 x 110 mm

✂ TXP - 200 x 200 mm





**CARDINAL • 92997**

Non-woven foldable bag (80 g/m<sup>2</sup>) with 35 cm handles. This product is supplied folded.

☒ Folded: 135 x 130 x 15 mm | Open: 350 x 410 x 100 mm  
 ⚡ TXP - 250 x 200 mm



**ARLON • 92993**

Non-woven foldable bag (80 g/m<sup>2</sup>) with 38 cm handles. This product is supplied folded.

☒ Folded: 200 x 110 x 15 mm | Open: 380 x 465 mm  
 ⚡ TXP - 260 x 260 mm



**COVENT • 92847**

Non-woven foldable bag (80 g/m<sup>2</sup>) with 50 cm handles. Thermo sealed.

☒ Folded: 110 x 132 x 20 mm | Open: 360 x 410 x 80 mm  
 ⚡ TXP - 150 x 200 mm



**SHOPS • 92906**

190T foldable bag with 50 cm handles. This product is supplied unfolded.

☒ 370 x 400 mm  
 ⚡ TXP - 160 x 220 mm

# FOLDABLE BAGS

Practical and versatile  
Ideal to bring in a handbag



## **PERTINA** • 92998

Non-woven foldable shopping bag (80 g/m<sup>2</sup>) with 65cm handles.

⌄ Folded: 200 x 120 mm | Open: 400 x 450 x 200 mm  
✂ TRS - 230 x 280 mm



SH

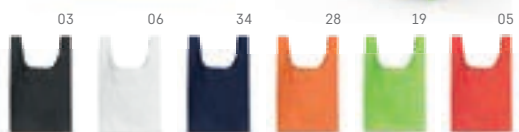

## **PLAKA** • 92915

210D foldable bag with 70 cm handles and inner pocket. This product is supplied unfolded.

⌄ Folded: 112 x 145 x 20 mm | Open: 370 x 400 x 100 mm  
✂ TXP - 250 x 250 mm



## **FOLA** • 92925

190T polyester foldable shopping bag.

⌄ Folded: 120 x 100 mm | Open: 485 x 420 mm  
✂ TRS - 80 x 60 mm



14

**MAYFAIR • 98423**

210D folding cooler bag with 60cm webbing handles. This product has a capacity of up to 16 L.

∓ 400 x 440 x 130 mm

✂ TRS - 80 x 180 mm



19

**MILLENIA • 92833**

Non-woven laminated bag (110 g/m<sup>2</sup>) with 60 cm handles and glossy lamination.

∓ 400 x 360 x 120 mm

✂ TXP - 260 x 220 mm



17

07

**SAWGRASS • 92850**

Non-woven laminated bag (90 g/m<sup>2</sup>) with 50 cm handles and glossy lamination.

∓ 340 x 350 x 80 mm

✂ TXP - 220 x 250 mm



**ARASTA • 92924**

Non-woven bag (140 g/m<sup>2</sup>) with 65 cm handles.  
With trolley band.

☒ 350 x 350 x 200 mm



06

SH



**WESTFIELD • 92856**

Non-woven laminated bag (120 g/m<sup>2</sup>) with  
60 cm webbing handles and glossy lamination.

☒ 420 x 380 x 120 mm

☒ TXP - 270 x 240 mm

03

06

03



**ARLETA • 92859**

Non-woven laminated shopping bag (110 g/m<sup>2</sup>)  
with front pocket (175 g/m<sup>2</sup>).

☒ 381 x 330 x 200 mm

☒ TXP - 130 x 100 mm

03





### SHOPPER • 92843

Non-woven bag (80 g/m<sup>2</sup>) with 50 cm handles.

⊥ 400 x 340 x 200 mm

✂ TRS - 230 x 120 mm



### BEACON • 92905

Non-woven bag (80 g/m<sup>2</sup>) with 55 cm handles. Thermo sealed.

⊥ 480 x 380 x 85 mm

✂ TRS - 280 x 200 mm



### NICK • 92908

Non-woven bag (80 g/m<sup>2</sup>) with front pocket and 60 cm handles.

⊥ 400 x 350 x 150 mm

✂ TRS - 240 x 160 mm

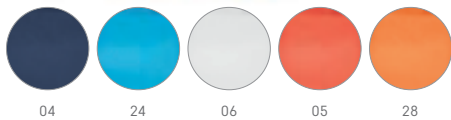

### DALE • 92916

Non-woven bag (80 g/m<sup>2</sup>) with 50cm handles. Thermo sealed.

⊥ 320 x 380 x 90 mm

✂ TRS - 200 x 280 mm

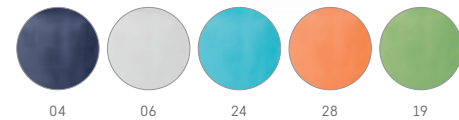

### SAVILE • 92497

Non-woven bag (80 g/m<sup>2</sup>) with 50 cm handles.

⊥ 400 x 350 x 70 mm

✂ TRS - 280 x 200 mm



**TARABUCO • 92921**

Non-woven bag with printed pattern and thermo sealed.

▮ 380 x 415 mm  
 ▸ TRS - 200 x 280 mm



SH



**HARROD • 92881**

Non-woven bag (80 g/m<sup>2</sup>) with 85 cm handles.

▮ 350 x 370 x 90 mm  
 ▸ TRS - 150 x 250 mm



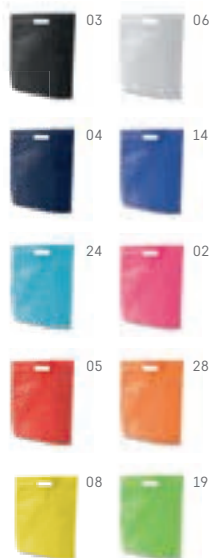

08

**STRATFORD • 92499**Non-woven bag (80 g/m<sup>2</sup>). Thermo sealed.

☒ 355 x 390 x 85 mm

✂️ TRS - 260 x 260 mm



28

**WOODBURY • 92832**Non-woven bag (80 g/m<sup>2</sup>) with 55 cm handles. Thermo sealed.

☒ 330 x 390 x 80 mm

✂️ TRS - 230 x 250 mm



06

**ROTTERDAM • 92845**Non-woven bag (80 g/m<sup>2</sup>). Thermo sealed.

☒ 250 x 350 x 80 mm

✂️ TRS - 200 x 200 mm



04

**WEMBLEY • 92840**Non-woven bag (80 g/m<sup>2</sup>) with 30 cm handles.

☒ 200 x 250 x 70 mm

✂️ TRS - 140 x 150 mm



**CANARY • 92839**

Non-woven bag (80 g/m<sup>2</sup>) with 75 cm handles.  
Thermo sealed.

☒ 380 x 415 x 85 mm  
✂ TXP - 260 x 260 mm



**NOTTING • 92895**

Non-woven bag (80 g/m<sup>2</sup>) with 30 cm handles.  
Thermo sealed.

☒ 380 x 415 x 85 mm  
✂ TRS - 200 x 280 mm



**MACY • 92854**

Non-woven bag (80 g/m<sup>2</sup>) with 55 cm handles.  
Thermo sealed.

☒ 270 x 350 mm  
✂ TRS - 200 x 200 mm



### CARNABY • 92910

210D drawstring bag.

☒ 350 x 410 mm

✂ TXP - 250 x 250 mm



### BOXP • 92904

Non-woven drawstring bag (80 m / g²).

☒ 370 x 410 mm

✂ TRS - 230 x 280 mm



05

SH



**COLMAR • 92912**

210D drawstring bag with front pocket and headphone output.

▮ 350 x 400 mm

♣ TRS - 200 x 260 mm



03

**SANCHO • 72478**

210D polyester backpack with one main pocket. This backpack is suitable for sublimation customisation.

▮ 380 x 460 mm

♣ TRS - 165 x 200 mm



08



14



28



08

**RULES** • 92835

210D drawstring bag with reflective elements.  
This product is a promotional product.

☒ 350 x 400 mm

☒ TXP - 160 x 250 mm



04



03



31

**GERE** • 92490

Non-woven shoulder bag (80 g/m<sup>2</sup>)  
with 95 cm handle.

☒ 350 x 390 x 60 mm

☒ TXP - 260 x 260 mm



05



19



KY





**LAVRE • 93324**



NATURA set with ball pen and metal keyring with cork finish. This customisable set is supplied in a gift box.

Ball pen: Ø9 x 139 mm | Keyring: 24 x 47 x 3 mm |

Box: 162 x 83 x 17 mm

DUV - 50 x 100 mm



60

KY



60



**CORKS • 93145**

Cork and metal keyring. This customisable keyring is supplied in a gift box.

20 x 100 mm | Box: 54 x 125 x 16 mm

LSR - 10 x 15 mm



60



**RALDIC • 93371**

Cork and metal keyring. This customisable keyring is supplied in a gift box.

24 x 47 x 3 mm

LSR - 12 x 30 mm





**BACHMANN • 93171**

Metal and imitation leather round keyring. This customisable keyring comes in a gift box.

▮ 38 x 76 x 9 mm  
 ⚡ PDP - 10 x 30 mm



**KLODEN • 93172**

Imitation leather and metal keyring. This customisable keyring comes in a gift box.

▮ 39 x 74 x 5 mm  
 ⚡ LSR - 12 x 27 mm



**BALE • 93143**

Keyring in imitation leather and metal. This customisable keyring is supplied in a gift box.

▮ 22 x 65 x 8 mm  
 ⚡ LSR - 15 x 30 mm



05

**WATOH • 93354**

Imitation leather and metal keyring. This customisable keyring is supplied in a gift box.

▮ 18 x 90 x 7 mm  
 ↗ LSR - 13 x 25 mm

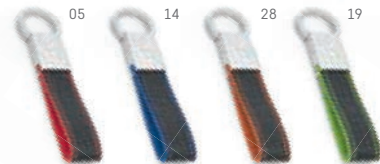

14

**LESKOV • 93370**

Imitation leather and metal keyring with swivel carabiner. This customisable keyring is supplied in a gift box.

▮ 17 x 80 x 7 mm  
 ↗ LSR - 13 x 20 mm



03

**BLACKWALL • 93353**

Imitation leather and metal keyring. This customisable keyring is supplied in a gift box.

▮ 21 x 100 x 11 mm  
 ↗ LSR - 6 x 15 mm



03

**BOURCHIER • 93363**

Metal and imitation leather keyring with hook. This customisable keyring is supplied in a gift box.

▮ 21 x 77 x 8 mm  
 ↗ LSR - 15 x 20 mm





### PORTHOS • 93399

Metal coin holder provided supplied in a gift box.

☒ Coin: Ø24mm | 32 x 40 mm.

☒ LSR - 8 x 17 mm



27



### LOCK • 93082

Metal keyring. This customisable keyring comes in a gift box.

☒ 24 x 27 x 7 mm

☒ LSR - 10 x 20 mm



27



### ZABEL • 93158

Metal keyring.

☒ 30 x 54 x 4 mm

☒ LSR - 17 x 30 mm





03

KY



**FLEMI • 93397**

Metal keyring. This customisable keyring comes in a gift box.

▮ 28 x 52 x 3 mm

▮ LSR - 20 x 25 mm



47



**DIAMOND • 93395**

Metal keyring. This customisable keyring comes in a gift box.

▮ 28 x 47 x 4,5 mm

▮ LSR - 14 x 22 mm



47



**FROOME • 93396**

Metal keyring. This customisable keyring comes in a gift box.

▮ 32 x 53 x 4,5 mm

▮ LSR - 12 x 25 mm



**ATRIA** • 23203

Metal keyring supplied in gift box.

▮ 35 x 80 mm  
♣ LSR - 20 x 15 mm



**FORLUCK** • 23187

Metal keyring supplied in gift box.

▮ 37 x 72 mm  
♣ LSR - 20 x 4 mm



**AMOR** • 93329

Metal heart shaped keyring supplied in gift box.

▮ 36 x 41 mm  
♣ LSR - 17 x 25 mm





07

### WAGONER • 93341

Truck-shaped metal keyring. This customisable keyring is supplied in a gift box.

▮ 26 x 71 x 3 mm  
 ▮ LSR - 15 x 35 mm



KY



07

### HELLI • 93394

Metal keyring with bottle opener.

▮ 22 x 42 x 9 mm  
 ▮ LSR - 9 x 20 mm



07

### ULRICH • 93084

Metal house-shaped keyring. This customisable keyring is supplied in a gift box.

▮ 49 x 36 x 3 mm  
 ▮ LSR - 25 x 15 mm





KY



05

**BASSO • 93391**

Heart shaped metal and ABS keyring.

▮ 42 x 34 x 4 mm

▮ LSR - 20 x 15 mm



14



05

28

08

03

14

19

**BECKET • 93372**

Metal and ABS keyring.

▮ 29 x 40 x 4 mm

▮ LSR - 25 x 25 mm



**97152**

TECNOLOGY  
PG. 107





**ALBRIGHT • 93177**

Imitation leather and metal keyring.

▮ 39 x 57 x 5 mm  
 ⚡ LSR - Ø23 mm



**BUMPER • 93178**

Imitation leather and metal keyring. This customisable keyring comes in a gift box

▮ 20 x 56 x 5 mm  
 ⚡ LSR - 15 x 15 mm



**GRIPITCH • 93077**

Metal and webbing keyring. This customisable keyring comes in a gift box.

▮ 28 x 60 x 6 mm  
 ⚡ LSR - 18 x 25 mm



**INDURAIN • 93170**

Metal and silicone round keyring. This customisable keyring comes in a gift box.

▮ 36 x 66 x 5 mm  
 ⚡ LSR - Ø17 mm





**CLOVE • 93362**

Metal and PVC keyring. This customisable keyring is supplied in a gift box.

± 18 x 95 x 8 mm  
 ↗ LSR - 10 x 30 mm



**ANCHOR • 93369**

Metal and webbing keyring. This keyring with a slot for doming is supplied in a gift box.

± 27 x 61 x 5 mm  
 ↗ DOM - 20 x 25 mm





# IDEAL PRODUCTS TO CUSTOMIZE WITH DOMING



## **RINGBOLT** • 93368

Metal keyring with slot for doming, with bottle opener and carabiner. This customisable keyring is supplied in a gift box.

☒ 29 x 52 x 4 mm  
☒ LSR - 15 x 20 mm



## **BLAKE** • 93367

Metal keyring with slot for doming and bottle opener. This customisable keyring is supplied in a non-woven bag.

☒ 36 x 67 x 3 mm | Pouch: 60 x 100 mm  
☒ LSR - Ø18 mm



## **BOHR** • 93365

Metal keyring with slot for doming. This customisable keyring is supplied in a gift box.

☒ 24 x 53 x 4 mm  
☒ LSR - 14 x 30 mm





07

**FIDO • 93089**

Coin-shaped metal keyring.

23 x 80 mm

LSR - Ø21 mm



03

**SINNET • 93350**

PVC keyring.

27 x 53 x 3 mm

LSR - 20 x 30 mm



27

**STITCH • 93356**

Customisable aluminum keyring.

29 x 54 x 1 mm

LSR - 20 x 30 mm



27

**HOMIER • 93167**

Aluminum keyring in the shape of a house.

38 x 35 x 2 mm

LSR - 25 x 20 mm



27

**BEAT • 93159**

Heart-shaped aluminum keyring.

36 x 34 x 2 mm

LSR - 20 x 15 mm



27

**PAW • 93364**

Bone shaped aluminum keyring.

38 x 25 x 1 mm

LSR - 25 x 10 mm



**TRUDY • 93398**

Aluminum keyring with whistle.

- ∅ 7 x 45 mm
- LSR - 6 x 28 mm



**BAITT • 93151**

Aluminum keyring with bottle opener.

- 11 x 60 x 15 mm
- SCR - 8 x 40 mm



**FARRI • 98820**

Keyring with carabiner and PVC customisable area.

- 120 x 30 mm
- PDP - 10 x 10 mm



**MATTHEW • 58823**

Aluminum carabiner, with keyring and flat area for customisation. This product is not for climbing.

- 32 x 57 x 5 mm
- PDP - 3 x 30 mm



**98824**  
LEISURE  
& TRAVEL  
PG. 244



**LED** **NOHO • 93071**

Keyring with LED light. This customisable keyring includes 3 LR41 batteries.

▮ 25 x 60 x 5 mm  
 ↗ PDP - 12 x 40 mm

**LED** **CLEAT • 93360**

ABS keyring with LED light. This customisable keyring includes 3 AG10 batteries.

▮ 31 x 77 x 14 mm  
 ↗ PDP - 15 x 35 mm



**BERRY • 93339**

Fluorescent bear shaped keyring.

▮ 60 x 66 mm  
 ↗ PDP - 20 x 50 mm



**RESIDENCE • 93340**

Fluorescent house shaped keyring.

▮ 55 x 56 mm  
 ↗ PDP - 30 x 30 mm



**HOWIE • 95880**

Fluorescent triangular shaped keyring.

▮ 47 x 41 mm  
 ↗ PDP - 30 x 20 mm



**LED LERGAN • 93141**

Aluminum keyring with 3 LED lights. This customisable keyring includes 4 LR44 batteries.  
 ∅ 17 x 62 mm  
 PDP - 7 x 25 mm



KY



**LED TOKEN • 94748**

Keyring with 2 LEDs and plastic coin. Includes 2 CR1220 batteries.  
 70 x 10 x 25 mm  
 PDP - 35 x 15 mm



**LED GLOAMIN • 21125**

Lamp shaped keyring with LED light inside. This customizable keyring includes 4 batteries.  
 ∅ 29 x 51 mm  
 PDP - 15 x 5 mm





**SULLIVAN • 95018** **MADE IN EUROPE**

Keyring. PS coin-shaped.  
 ⚓ 25 x 60 x 2 mm  
 ⚡ PDP - 15 x 20 mm



**BUS • 95019** **MADE IN EUROPE**

Keyring. ABS coin-shaped.  
 ⚓ 33 x 48 x 6 mm  
 ⚡ PDP - 20 x 30 mm



**HEARTY • 93191**

Heart-shaped anti-stress keyring.  
 ⚓ 45 x 45 x 30 mm  
 ⚡ PDP - 15 x 10 mm



**BOXER • 23185**

Box glove shaped anti-stress keyring.  
 ⚓ 60 x 40 x 73 mm  
 ⚡ LSR - 20 x 20 mm





**LIME** • 93062 **MADE IN EUROPE**

PS keyring.  
 ⚓ 35 x 58 x 6 mm  
 ⚡ PDP - 20 x 30 mm



**BOLING** • 93063 **MADE IN EUROPE**

PS keyring.  
 ⚓ Ø40 x 5 mm  
 ⚡ PDP - 20 x 20 mm

KY



**BOWEN** • 93056 **MADE IN EUROPE**

PS keyring.  
 ⚓ 43 x 55 x 5 mm  
 ⚡ PDP - 20 x 20 mm



**BELAIR** • 93076 **MADE IN EUROPE**

PS keyring with slot to place  
 customised paper inside.  
 ⚓ 31 x 73 x 5 mm  
 ⚡ PDP - 20 x 40 mm



**ASHLEY • 94124**

Keyring with 1 m measuring tape.  
 40 x 40 x 9 mm  
 SCR - 25 x 25 mm



**HOUSE • 94135**

Keyring with 1 m tape measure. This customizable keyring is home shaped.  
 45 x 14 x 52 mm  
 PDP - 35 x 20 mm



**KEYTER • 23192**

Promotional keyring with 1m tape measure.  
 40 x 15 x 44 mm  
 PDP - 25 x 25 mm



**COPPI • 94129**

Keyring with 1.5 m measuring tape with break.  
 60 x 48 x 15 mm  
 PDP - 30 x 12 mm



# ORIGINAL LANYARDS®

MADE IN EUROPE



PANTONE®  
COLORS  
AVAILABLE

Choose our  
**TUBE, SUBLIMATION, NAUTIC,  
CORK OR LEATHER MODELS**



IN STOCK



Choose one of our  
**ACCESSORIES**



Choose  
**SIZE**



DELIVERY TIME:  
from 9 business days

FIND OUT MORE ON P. 494

ORIGINAL LANYARDS®



19

20 mm



**LARIAT • 94405**

Polyester lanyard with metal carabiner.  
 20 x 480 mm  
 TRS - 16 x 280 mm



08

20 mm

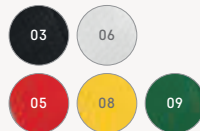

**VALMONT • 94409**

Polyester lanyard with metal carabiner and safety lock.  
 20 x 480 mm  
 TRS - 16 x 280 mm



24

20 mm



**ANQUETIL • 94401**

Polyester lanyard with metal carabiner.  
 20 x 530 mm  
 TRS - 16 x 280 mm



28

20 mm

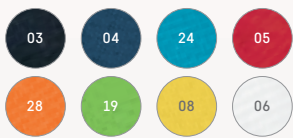

**MURRAY • 94402**

Polyester lanyard with metal carabiner and safety lock.  
 20 x 510 mm  
 TRS - 16 x 280 mm



19



**NICOLAUS • 94446**

Silicone card holder with lanyard and smartphone holder.  
 Card holder: 57 x 86 x 4 mm |  
 Lanyard: 420 mm  
 SCR - 32 x 40 mm



05

Ø5 mm



**WEAVE • 94408**

Adjustable polyester lanyard with metal snap hook and slot for doming.  
 Ø5 x 450 mm  
 PDP - Ø20 mm



28

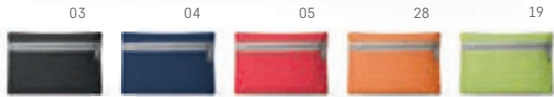

**VIVIANI • 92729**

Small 600D multipurpose bag with keyring inside.

⊥ 170 x 110 mm  
 ✂ TRS - 100 x 50 mm



19



**MILLER • 93124**

Small 600D pouch with keyring.

⊥ 120 x 80 mm  
 ✂ TRS - 90 x 40 mm



10

**WHITMAN • 93359**

PVC badge holder.  
 ⊥ 110 x 170 mm  
 ✂ SCR - 15 x 50 mm



10

**FORSYTH • 93357**

PVC badge holder.  
 ⊥ 110 x 90 mm  
 ✂ PDP - 50 x 15 mm



**94970**

LEISURE  
 & TRAVEL  
 PG. 234



PE



### MURPHY • 93323

The MURPHY set includes a metal ballpoint pen with touch tip and a metal and imitation leather card holder. This set is supplied in a gift box.

☒ Ball pen: Ø10 x 133 mm | Cardholder: 97 x 63 x 14 mm |  
 ☒ Box: 110 x 155 mm  
 ✂ LSR - 10 x 50 mm



03

PE



### TRAVOLTA • 93314

The TRAVOLTA set includes a card holder and keyring, both metal and imitation leather products. This customisable set is supplied in a gift box.

☒ Keychain: 15 x 92 x 8 mm | Cardholder: 97 x 65 x 11 mm |  
 ☒ Box: 154 x 143 x 34 mm  
 ✂ LSR - 7 x 25 mm



23





**MULLER • 93332**

Aluminum card holder with RFID notepading technology and polyester elastic strap. This card holder has a matte finish and has capacity for 12 cards.

▮ 90 x 58 mm  
 ⚡ LSR - 50 x 20 mm



**REEVES • 93307**

Aluminum and imitation leather cardholder. This product is supplied in a box.

▮ 96 x 64 x 13 mm | Box: 105 x 70 x 15 mm  
 ⚡ LSR - 35 x 10 mm



**COSTNER • 93306**

Aluminum cardholder.

▮ 95 x 65 x 7 mm  
 ⚡ LSR - 80 x 30 mm



**BRONI • 93310**

Aluminum card holder.

▮ 108 x 72 x 19 mm | Box: 112 x 75 x 20 mm  
 ⚡ LSR - 75 x 70 mm





03

**SANDLER • 93309**

Mirrored metal and imitation leather card holder. This product is supplied in a gift box.

▮ 95 x 65 x 13 mm | Box: 105 x 70 x 15 mm

♣ LSR - 85 x 8 mm



03

**MILLARD • 93280**

Metal card holder with imitation leather details, supplied in a box.

▮ 95 x 64 x 13 mm

♣ LSR - 80 x 8 mm



60



**DANIEL • 93319**

Cork card holder with capacity for 4 cards and compartment for bills. This environmentally friendly card holder is supplied in a gift box.

▮ 68 x 106 mm | Box: 75 x 115 x 15 mm

♣ LSR - 50 x 50 mm



01

**SMITH • 93308**

Metal and imitation leather cardholder. This product is supplied in a box.

▮ 97 x 63 x 14 mm | Box: 105 x 70 x 15 mm

♣ LSR - 50 x 10 mm





21



**GOLIASH • 93326**

Leather wallet with 2 bill pockets, 1 coin pocket, 3 additional pockets and a capacity for up to 4 cards. Product supplied in a box.

▮ 125 x 100 x 10 mm | Box: 140 x 115 x 30 mm  
 ↗ HTS - 50 x 20 mm



03



**AFFLECK • 93317**

Leather wallet with coin pocket and capacity for three cards. This wallet is supplied in a gift box.

▮ 110 x 92 x 13 mm | Box: 130 x 109 x 24 mm  
 ↗ SCR - 50 x 50 mm



03



**MALINI • 93279**



Men's leather belt with reversible metal buckle and supplied in a gift box.

▮ 1250 x 33 mm | Box: 128 x 148 x 45 mm  
 ↗ PDP - 50 x 20 mm





03



**GASPARO • 93298**

Bright leather wallet with 3 bill compartments, 1 zippered compartment, 1 coin pocket, 6 additional pockets and capacity for 7 cards. Supplied with gift box.

▮ 120 x 96 x 18 mm | Box: 140 x 115 x 30 mm  
 ⚡ PDP - 45 x 25 mm



03



**BARRYMORE • 93222**

The BARRYMORE leather wallet has a coin pocket and can hold 9 cards. This wallet is supplied in a gift box.

▮ 125 x 98 x 20 mm | Box: 140 x 113 x 30 mm  
 ⚡ SCR - 80 x 50 mm



PE



03



**KUTCHER • 93316**

Leather card holder with a capacity for 4 cards and a compartment for bills. This product is supplied in a gift box.

▮ 65 x 106 mm | Box: 80 x 115 x 15 mm  
 ⚡ HTS - 40 x 40 mm



03

**LONE • 93318**

Metal and imitation leather double card holder. This card holder is supplied in box.

▮ 93 x 67 x 19 mm | Box: 98 x 72 x 22 mm  
 ⚡ LSR - 70 x 7 mm



04

**KEVIN • 92728**

High density 300D cosmetic bag with handle, front pocket and lined interior.

☒ 220 x 115 x 115 mm

✂ TRS - 120 x 40 mm



13



03

**WILLIS • 92724**

Microfiber toiletry bag with multiple inner pockets and hanging hooks.

☒ 200 x 160 x 85 mm

✂ TRS - 120 x 60 mm



05



**EASTWOOD • 92730**

600D cosmetic bag with handle and lined interior.

☒ 220 x 120 x 120 mm

✂ TRS - 140 x 60 mm



PE



**WAYNE • 92732**

High-density 600D toiletry bag with handle and lined interior.

▮ 220 x 110 x 110 mm

♣ TRS - 140 x 60 mm



13





**MARILYN • 92727**

Microfiber cosmetic bag with front pocket and a small multipurpose bag.  
 ☒ 230 x 150 x 70 mm | Small pouch: 180 x 110 mm  
 ✂ TRS - 160 x 80 mm



**ANNIE • 92717**

Microfiber and mesh cosmetic bag.  
 ☒ 210 x 130 x 85 mm  
 ✂ TRS - 90 x 90 mm



**CROWE • 92715**

Microfiber cosmetic bag with details in imitation of leather.  
 ☒ 180 x 120 x 100 mm  
 ✂ TRS - 30 x 15 mm



PE



02



23



44



02

**ELIZA • 92731**

High density 300D cosmetic bag with padded handle, lined interior and zipper pocket with zipper.

☒ 200 x 115 x 140 mm

☒ TRS - 140 x 60 mm







PE



06

**VALENTINA • 92720**

Airtight PVC cosmetic bag. Suitable for traveling by plane. Bottles not included.

- ☒ 165 x 185 x 40 mm | Capacity < 1 Liter
- ✂ SCR - 110 x 110 mm



10

**DENIRO • 92722**

Airtight PVC cosmetic bag that includes 3 bottles (2 x 65 ml and 1 x 60 ml), 1 vaporizer (80 ml) and 1 funnel. Ideal for traveling by plane.

- ☒ 190 x 155 x 40 mm
- ✂ SCR - 120 x 100 mm



06



03

**FLORENCE • 94899**

Metal handbag hook.  
 ⊥ 045 x 8 mm  
 ↗ PDP - 25 x 25 mm



02



**LOREN • 92713**

Multiuse PVC bag with metallic colours.  
 ⊥ 140 x 95 x 70 mm  
 ↗ SCR - 90 x 50 mm

PE



04

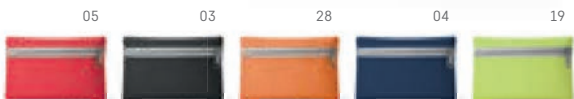

**VIVIANI • 92729**

Small 600D multipurpose bag with keyring inside.  
 ⊥ 170 x 110 mm  
 ↗ TRS - 100 x 50 mm



14

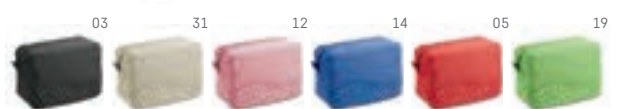

**MARIE • 92721**

Microfiber multiuse pouch.  
 ⊥ 130 x 90 x 65 mm  
 ↗ TRS - 90 x 30 mm



94849

06



94848

03



**SONIA • 94848 / 94849**

Imitation leather manicure set that includes 5 accessories.

▮ 110 x 65 x 20 mm

✂ PDP - 30 x 20 mm



12

06

**NADIA • 94843**

Manicure set that includes 4 accessories.

▮ 100 x 53 x 20 mm

✂ PDP - Ø20 mm



10



**LOPEZ • 94857**

Manicure set in PVC bag. This set includes 4 pieces.

▮ 66 x 105 mm

✂ SCR - 30 x 40 mm



03



**VILMA** • 94862



Six-piece stainless steel manicure set with imitation leather case. This product is supplied in a gift box.

☒ Box: 160 x 90 x 25 mm

☒ DGL - 90 x 50 mm

PE



37



**JENETTE** • 92198

Six-piece stainless steel manicure set, supplied in imitation leather pouch.

☒ 78 x 120 mm

☒ PDP - 30 x 35 mm

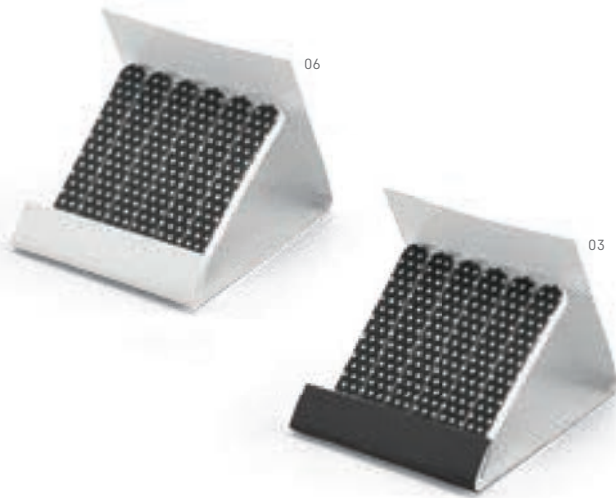

### ANISTON • 94856

Set of 6 files supplied in cardboard box.

☒ 55 x 61 x 6 mm  
 ✂ PDP - 30 x 40 mm



### RASPERA • 94861

Glass nail file supplied in a box.

☒ 12 x 140 x 3 mm  
 ✂ STI - 8 x 30 mm



### PIAF • 94800

Make-up mirror with foldable brush.

☒ 105 x 35 x 25 mm  
 ✂ SCR - 70 x 20 mm





03



27

**GAVIS • 94835**

Double make-up mirror.  
 ☿ 68 x 64 x 11 mm  
 ✂ SCR - 50 x 20 mm



07



**SHIMMER • 94860**

Double metal pocket mirror. Suitable for sublimation printing. Supplied in a box.  
 ☿ Box: 67 x 75 x 9 mm  
 ✂ LSR - 45 x 45 mm



02

02

06

04

03

**STREEP • 94853**

Round make-up mirror.  
 ☿ Ø60 x 5 mm  
 ✂ SCR - 40 x 40 mm



19

28

02

24

24

**AMELIA • 94845**

Double make-up mirror.  
 ☿ Ø68 x 9 mm  
 ✂ PDP - Ø25 mm



### ERIC • 94891

SPF30 sunscreen with a capacity up to 30 ml. The packaging of this sunscreen has a metal carabiner.

∅ 93 x 50 x 23 mm  
 PDP - 35 x 25 mm



### JOLIE • 94851

Lip balm.

∅ 19 x 68 mm  
 PDP - 9 x 35 mm



**BARDOT • 94881**

Lip balm with cube-shaped packaging in metallic ABS. This lip balm has SPF15 UV protection.

∓ 32 x 32 x 32 mm  
 ↗ PDP - 20 x 20 mm



**ALBA • 94882**

Lip balm with spherical metallic ABS packaging. This lip balm has SPF15 UV protection.

∓ Ø39 x 38 mm  
 ↗ PDP - 10 x 10 mm



**SCARLETT • 94880**

Lip balm with metallic ABS packaging. This lip balm has SPF15 UV protection.

∓ Ø18 x 68 mm  
 ↗ SCR - 12 x 30 mm





**LOVELY • 94356**

PVC heat pouch that generates heat instantly. The bag is heart shaped.

▮ 102 x 90 x 11 mm  
 ✂ PDP - 40 x 15 mm

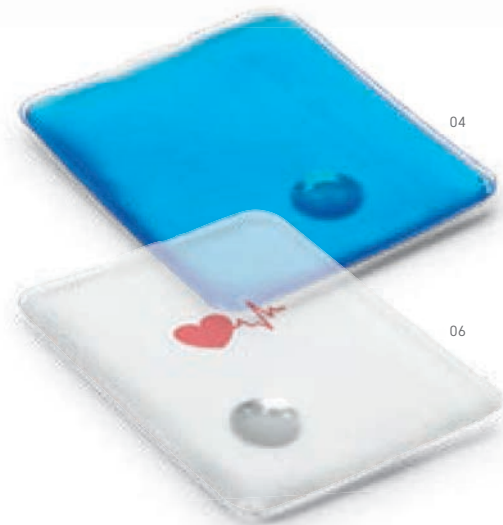

**CORDEN • 94353**

PVC heat bag that generates heat instantly. This promotional product is a reusable product.

▮ 88 x 110 mm  
 ✂ PDP - 10 x 45 mm

CALCULATES BODY  
 MASS INDEX



**KATSU • 94231**

1.5m ABS tape measure with Body Mass Index calculator. This tape measure is a promotional product that is supplied in box.

▮ 75 x 16 x 57 mm  
 ✂ PDP - 35 x 25 mm



**CLAUDE • 94352**

Plaster holder with 5 pieces included.

▮ 41 x 102 x 10 mm  
 ✂ SCR - 25 x 70 mm



**KYLE • 94357**

First aid kit including 5 band aids, 4 antiseptic wipes, gauze, adhesive and scissors. This kit is supplied in a 70D pouch.

∓ 88 x 115 x 50 mm  
 ✂ TRS - 70 x 20 mm

PE

**DAMON • 94890**

Spray hand sanitizer with lid and capacity up to 10 ml.

∓ Ø15 x 140 mm  
 ✂ PDP - 20 x 7 mm





03

**NEESON • 98093**

Anti-stress PU foam.

∅ 63 mm

PDP - 10 x 10 mm



06

**RUGBY • 98092**

Anti-stress PU foam.

91 x 58 x 58 mm

PDP - 30 x 10 mm



06

**LOHAN • 98091**

Anti-stress PU foam.

52 x 93 x 47 mm

PDP - 10 x 40 mm



28

**HOUS • 98057**

Anti-stress PU foam, house-shaped.

70 x 80 x 70 mm

PDP - 20 x 50 mm

**REDS** • 98059

**BLUS** • 98067

Anti-stress PU foam, drop-shaped.

∓ 65 x 110 x 65 mm

✂ PDP - 15 x 25 mm



**DEEP** • 98012

Anti-stress PU foam, heart-shaped.

∓ 65 x 70 x 50 mm

✂ PDP - 15 x 25 mm



**CHILL** • 98054

Anti-stress PU foam, ball-shaped.

∓ Ø50 mm

✂ PDP - Ø20 mm





PE



**NERO • 94307**

Pill box with cutter and 2 removable inner compartments.

⊞ 94 x 48 x 16 mm  
 ↗ PDP - 55 x 35 mm



**SNIPES • 94304**

Pill box with 8 compartments.

⊞ 102 x 70 x 22 mm  
 ↗ SCR - 30 x 15 mm



**JIMMY • 94305**

Pill box with 7 compartments.

⊞ 85 x 55 x 20 mm  
 ↗ PDP - 55 x 35 mm



**HOFFMAN • 94303**

**MADE IN EUROPE**

PP pill box with 3 compartments.

⊞ 70 x 50 x 15 mm  
 ↗ SCR - 40 x 20 mm



**ROBERTS • 94306**

Pill box with 4 compartments.

⊞ 60 x 60 x 18 mm  
 ↗ PDP - 20 x 20 mm





01

**MOOSE** • 99063

Moose-shapes plush blanket. The blanket is polar fleece (180 g/m²).

Blanket: 1200 x 800 mm | Plush toy: 200 x 245 mm

TRS - 280 x 200 mm



13



11

**BEARY** • 95505

Polyester teddy bear with front area suitable for customisation.

155 mm

TRS - 40 x 30 mm

KD



14



14



06



05

**BEAR** • 95500

Teddy bear wearing customisable polyester t-shirt.

120 mm

TRS - 35 x 25 mm



06

**GRIZZLY** • 95504

Teddy bear wearing customisable t-shirt, in polyester.

155 mm

TRS - 50 x 25 mm



60

**FAUNE • 99336**

Wooden set for painting. This set contains 3 figures with hanging ribbons and 4 colouring pencils.

▮ 122 x 94 x 14 mm

✂ PDP - 50 x 20 mm

60

**ANIM • 91758**

Painting set in cardboard box. This set includes 6 colouring pencils, 1 sharpener and 15 drawings to paint.

▮ 73 x 89 x 12 mm

✂ SCR - 55 x 50 mm

60

**JAGUAR • 91755**

Cardboard painting set. This set includes 8 crayons and 8 cards with drawings, to colour and hang.

▮ 180 x 90 x 10 mm

✂ DGL - 60 x 50 mm





**CUCKOO • 93466**

25 page colouring book.  
Colouring pencils not included.

∓ 90 x 90 mm  
✂ SCR - 70 x 60 mm



**TEJO • 94635**

PP and PS travel cup with flexible straw and capacity up to 200 ml. The cup is supplied with 3 colouring pages and 4 coloured pencils. This product is supplied in a gift box.

∓ Ø72 x 98 mm | Box: 90 x 117 x 75 mm  
✂ PDP - 25 x 30 mm

KD



**DRAWS • 92619**

Non-woven drawstring bag (80 m / g<sup>2</sup>) with drawing to colour and inner pocket. This product is supplied with 4 markers.

∓ 300 x 350 mm  
✂ TRS - 50 x 220 mm



**NILO • 99834**

Non-woven kids apron (80 g/m<sup>2</sup>) with drawing to colour, side pocket and 4 markers.

∓ 380 x 430 mm  
✂ TRS - 120 x 130 mm





### AGUZA • 93621

PS sharpener with rubber and shaving container.

☒ 41 x 60 x 23 mm

☞ PDP - 10 x 20 mm



### CAR • 91937

Set of 12 car-shaped rubbers supplied in a car-shaped box.

☒ Box: 72 x 32 x 12 mm

☞ PDP - 30 x 10 mm



### FILZ • 91938

Set of 8 colouring markers.

☒ 96 x 140 mm

☞ STI - 40 x 60 mm



### OSTADE • 11278

Painting set with 10 small (sharpened) colouring pencils, water colours with brushes and 1 sharpener.

☒ 145x15x122 mm

☞ PDP - 50 x 20 mm



60

**RHOMBUS • 91932**

Writing set that includes 16.5 cm ruler, 2 graphite pencils, 1 eraser and 1 sharpener. This set is supplied in a cardboard pouch.

▮ Pouch: 190 x 45 x 20 mm  
 ▮ SCR - 140 x 35 mm



50

**DOODLE • 91756**

Drawing set in wooden box. This set includes a 20 cm ruler, six colouring pencils, a graphite pencil, a sharpener and an eraser.

▮ 220 x 43 x 32 mm  
 ▮ LSR - 190 x 20 mm

KD



60

**PARROT • 91940**

Box with 4 coloured chalk sticks.

▮ Chalk: Ø22 x 106 mm | Box: 98 x 109 x 26 mm  
 ▮ SCR - 30 x 70 mm

SUPER BIG  
 (Ø22 mm)



**EAGLE** • 91754

Cardboard box with 6 crayons.

⊥ 53 x 92 x 9 mm  
 ✂ SCR - 30 x 40 mm

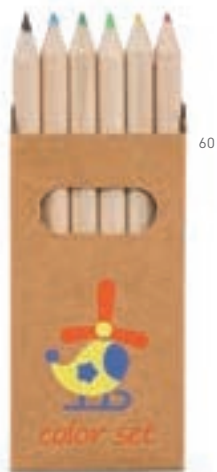

**BIRD** • 91750

Cardboard box with 6 colouring pencils.

⊥ 45 x 90 x 9 mm  
 ✂ SCR - 35 x 45 mm

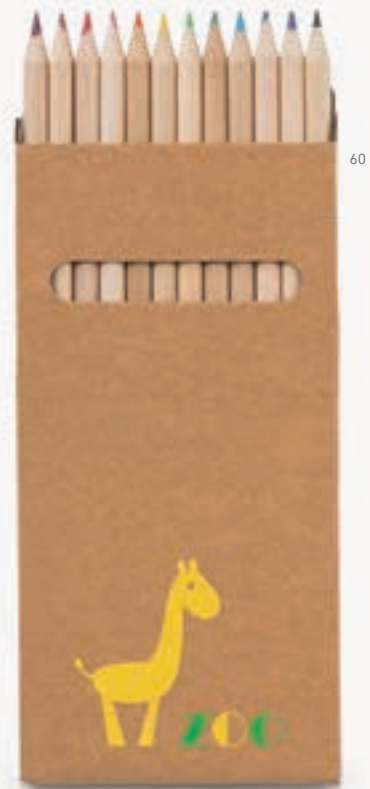

**CROCO** • 91746

Cardboard box with 12 colouring pencils.

⊥ 90 x 180 x 9 mm  
 ✂ SCR - 60 x 90 mm



**COLOURED** • 91747

Cardboard box with 12 colouring pencils.

⊥ 90 x 90 x 9 mm  
 ✂ SCR - 60 x 45 mm



**MEMLING • 91767**

Box with small fluorescent wooden colouring pencils (supplied sharpened).

∅ 90 x 10 x 48 mm  
 STI - 40 x 40 mm

KD



**ROLS • 91751**

Cardboard and plastic cylindrical sharpening box with colouring pencils.

∅ 26 x 103 mm  
 STI - 30 x 40 mm



**CYLINDER • 91752**

Cylindrical cardboard box with 12 colouring pencils.

∅ 35 x 97 mm  
 STI - 30 x 40 mm

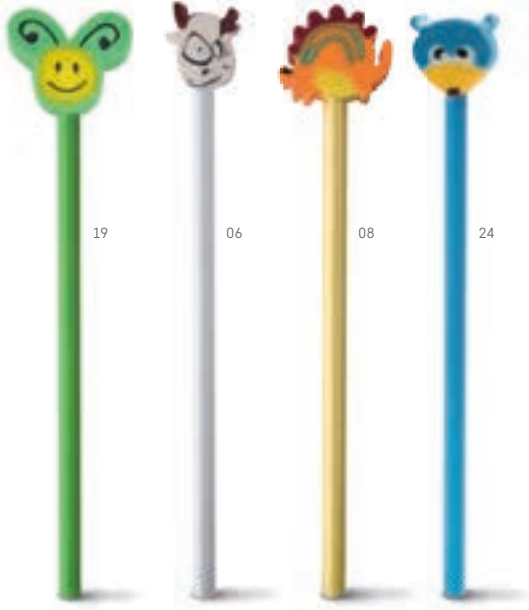

**BEETLE • 91904**

Pencil with rubber doll with different designs.

∅ 7 x 188 mm  
 PDP - 5 x 50 mm



**STORY • 93440**

Bookmark in wood.

30 x 340 mm  
 PDP - 15 x 15 mm

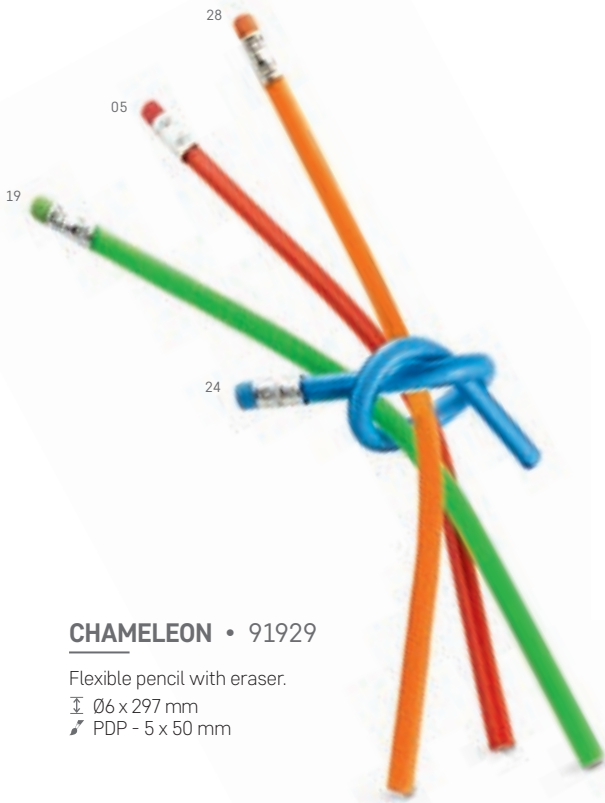

**CHAMELEON • 91929**

Flexible pencil with eraser.

∅ 6 x 297 mm  
 PDP - 5 x 50 mm



**FROG / LION • 93465 / 93464**

Wooden memo clip. Ideal for photos, reminders.

45 x 84 mm  
 PDP - 7 x 16 mm



24



06



24

19

06



### GEOM • 93575

Geometry school set in PP box. This set includes one compass, a mechanical pencil and 10 leads (0.5 mm).

▮ 128 x 42 x 20 mm

▮ PDP - 50 x 10 mm



24

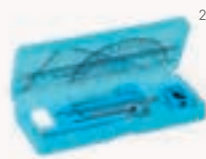

24



19



06

### PITAGORAS • 93574

Geometry school set in PP box. This set contains 9 pieces: 1 compass, 1 eraser, 1 sharpener, 1 pencil, 1 mechanical pencil, 10 leads (0.5 mm), 1 ruler, 1 square and 1 protractor.

▮ 165 x 68 x 25 mm

▮ SCR - 100 x 40 mm



**BISSAYA • 92617**

Non-woven 80 m/g<sup>2</sup>) drawstring bag.  
 300 x 350 mm  
 TXP - 200 x 200 mm



**COLORIT • 93619**

Non-woven pencil case.  
 210 x 110 mm  
 TRS - 150 x 60 mm

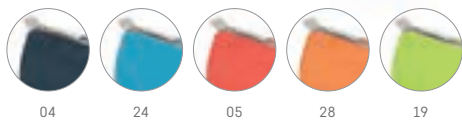

**HUMMINGBIRD • 93614**

600D pencil case.  
 210 x 85 x 65 mm  
 TRS - 130 x 60 mm



**SCHOOLI • 93607**

Cotton pencil case.  
 Ø70 x 220 mm  
 TRS - 60 x 130 mm





05

**TIGER • 92620**

600D backpack with mesh side pockets.  
 240 x 320 x 120 mm  
 TRS - 100 x 140 mm



24

**ROCKET • 92614**

600D backpack with mesh side pockets.  
 240 x 320 x 80 mm  
 TRS - 90 x 140 mm

KD



24



05



24



06



**TURTLE • 58412**



600D cooler bag with adjustable webbing strap.  
 200 x 200 x 110 mm  
 TRS - 120 x 120 mm



05



**SEBASTIAN • 98416**



600D cooler bag with adjustable webbing strap and capacity up to 3 L.  
 190 x 230 x 80 mm  
 TRS - 90 x 150 mm



Reflective material

**DUENA • 93330**

Elephant plush toy with "glow in the dark" effect. This product is a customizable keyring.

- ⊥ 130 mm
- ↗ DGL - 90 x 50 mm



**BERRY • 93339**

Fluorescent bear shaped keyring.

- ⊥ 60 x 66 mm
- ↗ PDP - 20 x 50 mm



**MIKE • 98501**

100% polyester reflective childrens vest. This product contains 2 horizontal reflective bands, a side velcro closure and has EN1150 certification. This product is not intended for professional use.

- ⊥ One size: 370 x 470 mm
- ↗ TRS - 40 x 230 mm



24



05



**READY** • 94604



PA and PE foldable bottle with capacity up to 350 ml.  
This product is BPA free.

∓ 120 x 210 mm  
✂ SCR - 50 x 70 mm



05



06



24



05



**CHALKIE** • 93957



Mug. Ceramic. Matt finish. Capacity up to 350 ml.  
Supplied in box. Chalk included.

∓ Ø81 x 96 mm | Box: 102 x 118 x 88 mm  
✂ SRC - 50 x 155 mm

KD



08



02



28



19



24



04

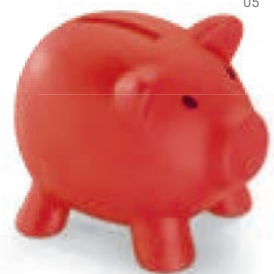

05

**PIGGY** • 93879

PVC piggy bank with lid on the base.  
Ideal for children's savings.

∓ 69 x 73 x 89 mm  
✂ PDP - 15 x 30 mm



50

**JUMPI • 98031**

Skipping rope with wodden handles ideal for playing outdoor.  
 ⌈ Handle: Ø40 x 80 mm | Rope: 2.200 mm  
 ⌋ PDP - 15 x 20 mm



03



**MAGNETIC • 98490**

Travel game with supplements. Supplied in a box.  
 ⌈ 130x80x15 mm  
 ⌋ PDP - 25 x 8 mm



05



**IOIO • 98016**

PS yo-yo.  
 ⌈ Ø59 x 15 mm  
 ⌋ SCR - Ø35 mm



50

**DOMIN • 98074**

Wooden domino game with animal figures.  
 ⌈ 147 x 50 x 30 mm  
 ⌋ SCR - 120 x 20 mm



00

**GAMY • 98007**

Set of 24 games, supplied in gift box.  
 ⌈ Each game: 40 x 40 x 40 mm |  
 Box: 255 x 170 x 42 mm  
 ⌋ PDP - 30 x 30 mm



**DUCK • 98077**

Yellow PVC rubber duck that is ideal for playing in the water.

⊥ 70 x 72 x 80 mm  
 ↗ STI - 20 x 40 mm

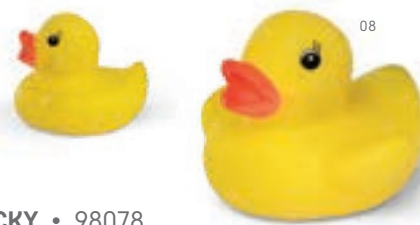

**DUCKY • 98078**

Yellow PVC rubber duck that is ideal for playing in the water.

⊥ 46 x 55 x 60 mm  
 ↗ STI - 20 x 40 mm



**ALDAN • 98457**

PP beach bucket with 6 beach accessories ideal for playing in the sand.

⊥ 110 x 155 x 90 mm | Bucket: Ø88 x 89 mm  
 ↗ DGL - 40 x 60 mm



**SNOWY • 98456**

Sled ideal to play in the snow.

⊥ 330 x 412 x 35 mm  
 ↗ PDP - 30 x 40 mm



**BUBBLY • 98076**

PP soap bubbles with a capacity of up to 30 ml and liquid included.

⊥ Ø25 x 130 mm  
 ↗ DOM - 27 x 27 mm



KD



24

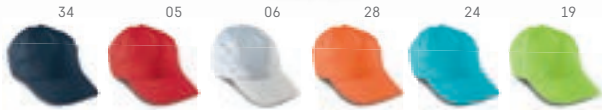

**CHILKA • 99456**

Polyester cap with adjustable velcro.

Size: 540 mm  
 TRS - 90 x 50 mm



34



**PANAMI • 99451**

Polyester bucket hat for children.

Size: 540 mm  
 TRS - 90 x 50 mm



00



**BAMBI • 99133**

Colourful polyester kid's umbrella with manual opening and EVA handle.

Ø680x550 mm  
 TRS - 150 x 90 mm



24

05

**LAVENDER • 99826**

Non-woven apron for children (80 g/m<sup>2</sup>) with pocket and adjustable.

400 x 600 mm | Pocket: 200 x 150 mm  
 TRS - 150 x 200 mm



Silver lining



Directional cable



### PARANA • 98320

210T umbrella with silver lining, directional cable and supplied in a pouch.

☒ Ø1400 mm | 1600 mm | Pouch: 1010 x 110 mm

☒ TRS - 230 x 150 mm

SM



### DERING • 98332

170T sunshade supplied in a pouch and ideal for days at the beach.

☒ Ø1400 mm | 1600 mm | Pouch: 1000 x 120 mm

☒ TRS - 230 x 150 mm



# WATERPROOF BAGS

SM



Waterproof



Adjustable shoulder strap



## PURUS • 92671

Bag, Colour 08: 190T. Colours 03, 05 and 14: tarpaulin. Waterproof. With carabiner clip and 1.5/2.5 L capacity.

⊥ 175 x 325 mm  
 ↗ TXP - 100 x 100 mm



## VOLGA • 92670

Bag. Tarpaulin. Waterproof. With adjustable shoulder strap and 3,5/5 L capacity.

⊥ Ø150 x 320 mm  
 ↗ TXP - 100 x 100 mm





SM



**CALIFORNIA • 98377**

microfiber beach towel (250 g/m<sup>2</sup>).  
 1500 x 750 mm  
 TRS - 280 x 200 mm

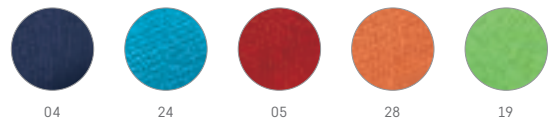

**SARDEGNA • 98375**

Cotton velvot beach towel (320 g/m<sup>2</sup>) supplied  
 in a non-woven bag (80 g/m<sup>2</sup>).  
 1500 x 750 mm | Bag: 330 x 415 x 100 mm  
 TRS - 200 x 150 mm



### CELEBES • 98313

PC sunglasses with 400 UV protection.

☒ 146 x 49 x 150 mm

☒ PDP - 30 x 7 mm



### NIGER • 98317

PC sunglasses with mirrored lenses and 400 UV protection.

☒ 146 x 49 x 150 mm

☒ PDP - 35 x 7 mm



### MEKONG • 98319

PC sunglasses with mirrored lenses, translucent frame and 400 UV protection.

☒ 146 x 49 x 150 mm

☒ PDP - 35 x 7 mm



### TOBOL • 92853

Non-woven pouch (80 g/m<sup>2</sup>) for sunglasses.

☒ 90 x 200 mm

☒ TRS - 50 x 100 mm



**SANTORINI • 98323**

PC sunglasses with 400 UV protection.

☒ 137 x 48 x 138 mm

☞ PDP - 30 x 7 mm



SM



**ZAMBEZI • 98321**

PC foldable sunglasses with 400 UV protection.

☒ 144 x 46 x 146 mm

☞ PDP - 30 x 6 mm



**GUAVIARE • 98483****MADE IN EUROPE**

PP and PVC fan.

☒ 180 x 240 x 4 mm

✂ SCR - 100 x 140 mm

**TIMOR • 98293**

Opaque PVC inflatable pillow.

☒ 310 x 185 x 130 mm

✂ SCR - 140 x 100 mm

**SENEGAL • 98300****MADE IN EUROPE**

PP beach ashtray with patented particle separation system and lid.

☒ Ø67 x 115 mm

✂ PDP - 25 x 40 mm

**PLATTE • 98316**

Tactile and waterproof 9.7" PVC tablet case that lets you interact with the screen from the outside.

☒ 215 x 329 mm

✂ SCR - 100 x 120 mm



SM



94632

DRINKWARE  
PG. 294



**EGEU • 98266**

Waterproof PVC mobile phone pouch with adjustable spring strap. The front part is clear and the back is matte white. The bag has airtight closure and colour flap with velcro closure.

▮ 240 x 95 mm  
▮ SCR - 120 x 60 mm





28



05

19

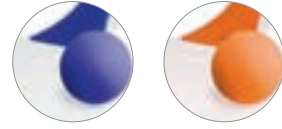

04

28

### FILIPINAS • 98035

MDF beach paddles with ball included.

∓ Ø190 x 330 x 5 mm

✂ SCR - 60 x 100 mm

SM



08



04

09

03

06



05

28

08

13

### YUKON • 98452

MADE IN EUROPE

PP flying disc.

∓ Ø210 x 27 mm

✂ SCR - Ø130 mm



19

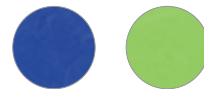

04

19



05

28

08

### JURUA • 98458

190T Foldable flying disc supplied in a pouch.

∓ Ø250 mm | Pouch: 90 x 90 mm

✂ SCR - 150 x 150 mm



05

**ALDAN • 98457**

PP beach bucket with 6 beach accessories ideal for playing in the sand.

∓ 110 x 155 x 90 mm | Bucket: Ø88 x 89 mm  
 ⚡ DGL - 40 x 60 mm



24

**KARON • 98260**

Clear PVC inflatable ball with inflatable doll inside.

∓ Ø180 mm  
 ⚡ SCR - 60 x 60 mm



28



24

SM

**MOOREA • 98259**

Inflatable ball with opaque and clear PVC.

∓ Ø180 mm  
 ⚡ TRS - 120 x 60 mm



08



19



00

**PARAGUAI • 98264**

Opaque PVC inflatable ball.  
 ∅ 210 mm  
 SCR - 120 x 60 mm



08

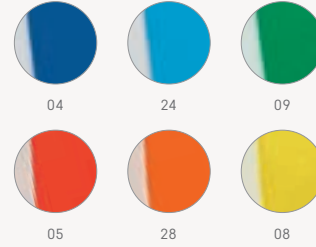

**CRUISE • 98274**

Opaque PVC inflatable ball, with stripes.  
 ∅ 210 mm  
 SCR - 120 x 60 mm



06

**TENERIFE • 98265**

Translucent frost PVC inflatable ball.  
 ∅ 245 mm  
 SCR - 120 x 60 mm



04

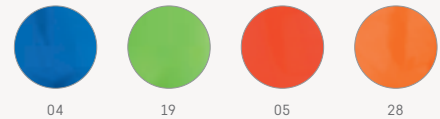

**PECONIC • 98219**

Translucent PVC inflatable ball.  
 ∅ 245 mm  
 SCR - 120 x 60 mm

SM







TR

AUTOMATIC RELEASE



**SOBRAL • 99141**

Cork umbrella with wooden shaft and handle.  
This umbrella has automatic opening.

∓ Ø1050 mm | 890 mm  
✂ TRS - 200 x 120 mm



### SESSIL • 99155

190T pongee umbrella, fiberglass ribs, aluminum shaft and rubber coated handle. This windproof and automatic opening umbrella is supplied in a pouch.

☒ Ø1025 mm | 855 mm | Pouch: Ø90 x 635 mm  
 ⚡ TRS - 200 x 100 mm



### ALBERT • 99131

Pongee 190T umbrella with fiberglass shaft and ribs, and rubber coated handle. This umbrella is windproof and has automatic opening.

☒ Ø1030 mm | 890 mm  
 ⚡ TRS - 200 x 120 mm



**PULA • 99156**

190T pongee umbrella, with fiberglass ribs, automatic opening and imitation leather handle with slot for doming. This umbrella is supplied in a pouch with a handle.

± 1100 x 825 mm  
 / TRP - 200 x 120 mm



TR

## REVERSIBLE UMBRELLA



**ANGELA • 99146**



190T pongee reversible umbrella with double cover, metal handle and fiberglass ribs. This patented structure has manual opening and automatic closing.

± Ø1050 mm | 790 mm  
 / TRS - 200 x 100 mm



03

**FELIPE • 99130**

190T pongee golf umbrella with fiberglass handle and ribs and PP handle. This umbrella is windproof and has automatic opening. Product supplied in a pouch.

∅ 1170 mm | 880 mm | Pouch: 85 x 725 mm  
 TRS - 200 x 120 mm



03

**GUIL • 99126**

190T polyester 12-rib umbrella with rubber-coated handle. This umbrella has automatic opening.

∅ 1100 mm | 900 mm  
 TRS - 130 x 130 mm



TR

05

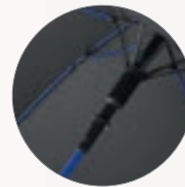

14

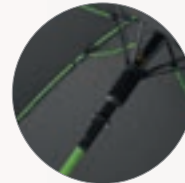

19

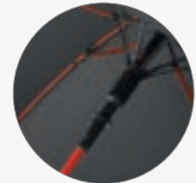

05

**ALBERTA • 99145**

Polyester umbrella with automatic opening.

∅ 1040 mm | 870 mm  
 TRS - 200 x 120 mm



04

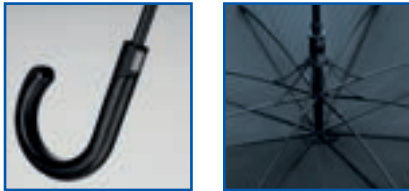

### SILVAN STRIPE • 99153

190T Pongee umbrella with glass rope ribs. This umbrella has automatic opening, imitation leather handle and is windproof.

∅ 1175 x 925 mm  
 TRS - 200 x 120 mm



TR

03



### HEDI • 99136

Pongee 190T 16-rib umbrella with wooden shaft and handle. This umbrella has automatic opening.

∅ 1110 mm | 945 mm  
 TRS - 130 x 130 mm



00



### DUHA • 99140

190T pongee rainbow umbrella with manual opening and wooden handle.

∅ 1020 x 875 mm  
 TRS - 120 x 100 mm





### JENNA • 99137

190T polyester umbrella with EVA handle. This umbrella has automatic opening.

∅ 1040 mm | 825 mm  
 TRS - 200 x 120 mm



### MICHAEL • 99134

190T polyester umbrella with rubber coated handle. This umbrella has automatic opening.

∅ 1040 mm | 830 mm  
 TRS - 200 x 120 mm



**MEGAN • 99152**

Polyester umbrella with automatic opening, reflective element and rubber coated handle.

∅ 960 x 815 mm  
 TYP - 200 x 120 mm



**KAREN • 99115**

190T polyester umbrella with aluminum shaft and handle. This umbrella has automatic opening.

∅ 1050 mm | 890 mm  
 TRS - 200 x 120 mm







06

### NICHOLAS • 99143

POE umbrella with automatic opening.

∅ 1000 mm | 815 mm

➤ PDP - 50 x 10 mm



04

### BETSEY • 99100

190T polyester umbrella with wooden shaft and handle.

∅ 1040 mm | 885 mm

➤ TRS - 200 x 120 mm

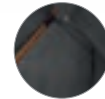

03



13



29

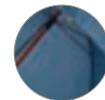

04

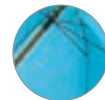

24



05



05



03

06

04

05

### ROBERTO • 99109

190T polyester golf umbrella with wooden handle.

∅ 1270 mm | 965 mm

➤ TRS - 200 x 120 mm



**PATTI • 99116**

190T polyester umbrella with wooden shaft and handle.  
This umbrella has automatic opening.

∅ 1040 mm | 885 mm  
TR - 200 x 120 mm



Automatic release

**JACOBS • 99144**

190T pongee foldable umbrella with rubber coated handle. This 3-section foldable umbrella is windproof and has automatic opening. This product is supplied in a pouch.

☒ Ø970 mm | 310 mm | Pouch: Ø50 x 250 mm  
 ✂ TRS - 200 x 120 mm



03



04



05

**CAMPANELA • 99151**

190T pongee compact umbrella with rubber coated handle and automatic opening. This umbrella is supplied in a pouch.

☒ Ø980 mm | 320 mm | Pouch: Ø50 x 240 mm  
 ✂ TRS - 200 x 120 mm

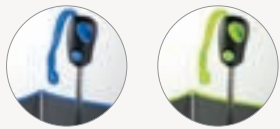

14

19

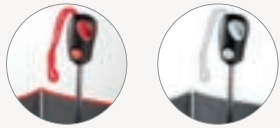

05

06



### DRIZZLE • 99150

190T pongee compact umbrella with automatic opening and closing and rubber coated handle. This umbrella is supplied in a pouch.

∅ 965 mm | 285 mm | Pouch: 055 x 225 mm  
 TRS - 200 x 120 mm

19



TR



### STELLA • 99147

190T pongee compact umbrella with rubber coated handle. This 3-section foldable umbrella is windproof and has automatic opening and closing. Product supplied in pouch.

∅ 970 mm | 280 mm | Pouch: 050 x 250 mm  
 TRS - 200 x 120 mm

03

AUTOMATIC OPENING  
AND CLOSING



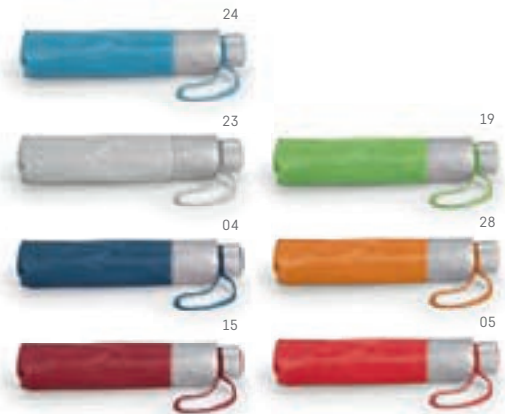

### TIGOT • 99135

190T polyester compact umbrella. This product is foldable into 3 sections and is supplied in a pouch.

∅ 960 mm | 240 mm | Pouch: ∅40 x 225 mm

TR - 200 x 120 mm



### MARIA • 99138

190T polyester compact umbrella. This product is foldable into 3 sections and is supplied in a pouch.

∅ 960 mm | 240 mm | Pouch: ∅40 x 215 mm

TR - 200 x 120 mm



TR

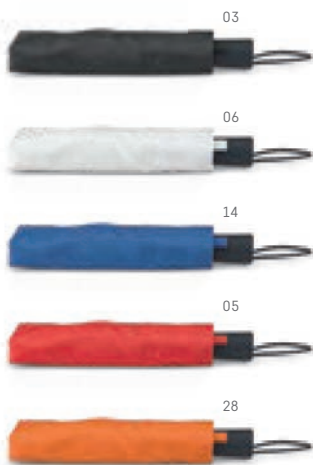

### TOMAS • 99139

190T polyester foldable umbrella. This 3-section foldable umbrella has automatic opening and is supplied in a pouch.

☒ Ø980 mm | 295 mm | Pouch: Ø45 x 245 mm  
☞ TRS - 200 x 120 mm





**PEDRO • 99215**

Waterproof poncho. This product is supplied in a packing with a hook.  
 ⊥ Ø63 mm | Poncho: one size  
 ⚡ PDP - 15 x 15 mm



**ISABEL • 99214**

Waterproof poncho. This product is supplied in a packing with a hook.  
 ⊥ Ø63 mm | Poncho: one size  
 ⚡ PDP - 20 x 20 mm



**SANDRA • 99213**

One size waterproof poncho.  
 ⊥ One size  
 ⚡ STI - 60 x 40 mm

TR



**CHARLOTTE • 99021**

Multifunction microfiber bandana (130 g/m²).  
 ⊥ 250 x 470 mm  
 ⚡ TRS - 150 x 180 mm

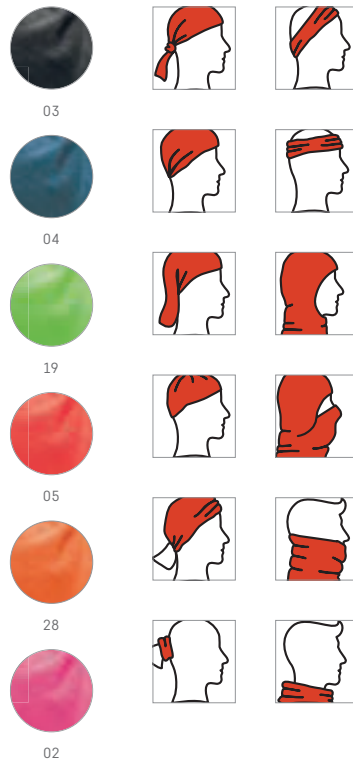

**TORY • 99018**

Polar fabric beanie (180 g/m²).  
 ⊥ 295 x 230 mm  
 ⚡ TRS - 90 x 50 mm



**PRABAL • 99017**

Polar fabric scarf (200 g/m<sup>2</sup>).

☒ 1500 x 250 mm

☞ TRS - 280 x 200 mm

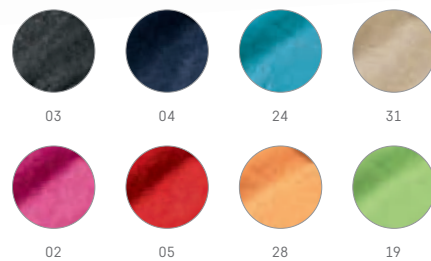

**JASON • 99011**

Scarf. Polar fleece: 200 g/m<sup>2</sup>.

☒ 1500 x 250 mm

☞ TRS - 280 x 200 mm



**THOM • 99016**

Synthetic mesh gloves with touch tips.

☒ Size: 8

☞ TRS - 50 x 40 mm



**ALEXANDRE • 99019**

Polar fabric gloves (200 g/m<sup>2</sup>).

☒ Size: 8

☞ TRS - 50 x 50 mm





**BLASS • 99409**

100% polyester hat with adjustable string.

Size: 580 mm  
 TRS - 90 x 55 mm



**JOSEPH • 99572**

Cotton canvas and polyester bucket hat.

Size: 580 mm  
 TRS - 90 x 50 mm



**PATRICIA • 99454**

6 panel cotton and polyester safari hat.

Size: 580 mm  
 TRS - 60 x 50 mm



BRUSHED COTTON

31

6 PANELS

"SANDWICH"



### CHRISTOPHE • 99412

100% brushed cotton sandwich cap with 6 panels and adjustable metal buckle.

Size: 580 mm  
TRS - 55 x 40 mm



03



04



31



06

TR

## COTTON CANVAS



04



03



04



31



04



31



03



### RADO • 99431

Cotton cap with adjustable metal buckle.

Size: 580 mm  
TRS - 60 x 50 mm



### CHRISTIAN • 99406

100% cotton canvas hat with 6 panels and adjustable metal buckle.

Size: 580 mm  
TRS - 55 x 40 mm



28



19



**JONES • 99418**

Polyester cap with reflective elements and adjustable velcro. This is a promotional product.

- Size: 580 mm
- TRS - 90 x 55 mm

**MIUCCIA • 99415**

6-panel polyester cap adjustable with velcro.

- Size: 580 mm
- TRS - 65 x 55 mm



06



34



**CLAIRE • 99568**

Polyester sandwich cap with adjustable velcro.

- Size: 580 mm
- TRS - 60 x 40 mm



04



**PHOEBE • 99457**

Denim cap, cotton and polyester, 6 panels and adjustable with metal buckle.

Size: 580 mm

TR - 55 x 45 mm

TR



05



34



05



06



**BROWNE • 99425**

microfiber and mesh cap adjustable with velcro.

Size: 580 mm

TR - 60 x 55 mm



05



14



05



03

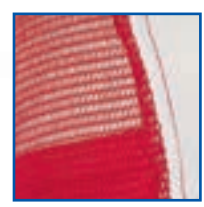

**NICOLA • 99426**

Polyester and net cap. This cap is adjustable with a plastic closure.

Size: 580 mm

TR - 90 x 55 mm



**BAILEY • 99410**

100% cotton cap with adjustable velcro.

Size: 580 mm  
 TRS - 90 x 55 mm



**STEFANO • 99537**

Polyester cap adjustable with velcro.

Size: 580 mm  
 TRS - 90 x 55 mm

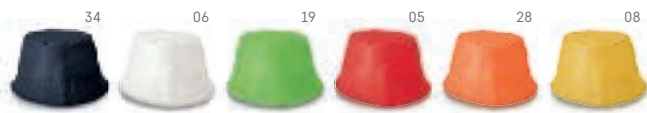

**JONATHAN • 99453**

Polyester bucket hat.

Size: 580 mm  
 TRS - 90 x 55 mm



**OLSEN • 99574**

Polyester bucket hat.

Size: 580 mm  
 TRS - 90 x 55 mm



08



24

TR



03



06



34



14



24



05



02



08



28



19



09

**CAMPBEL • 99547**

Polyester cap adjustable with velcro.

Size: 580 mm

TRS - 90 x 55 mm



60

**JEAN • 99419**

Natural straw hat. Ribbon not included.

- ☒ Size: 580 mm
- ✂ DGL - 60 x 40 mm



50

**EDWARD • 99423**

Natural straw hat. Ribbon not included.

- ☒ Size: 580 mm
- ✂ DGL - 60 x 40 mm



19

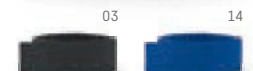

03

14

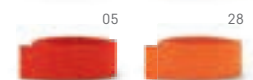

05

28



06

19

**BURTON • 99428**

100% polyester hat ribbon.

- ☒ 650 x 24 mm
- ✂ TRS - 380 x 18 mm

TR



02



19

03

02

06

05

14

28

**MANOLO • 99427**

PP hat. Ribbon not included.

- ☒ Size: 580 mm
- ✂ DGL - 60 x 40 mm



03



04

24

31

05

28

19

**DIANE • 99449**

Non-woven hat ribbon (80 g/m<sup>2</sup>).

- ☒ 650 x 22 mm
- ✂ TRS - 380 x 16 mm

## TH CLOTHES – THE BRAND

Th Clothes was born on 2006 with the purpose of filling the necessity to provide certificate quality products at a fair price. The clothing brand has as its main premise, the satisfaction of it's clients, without neglecting the social responsibility and the commitment with quality. All are products comply the criteria required by the STANDARD 100 by OEKO-TEX®, which as certification OEKO-TEX®, ensuring that the clients and users have a high and effective product security.



**Textile manufacture responsible and with quality assurance.**

Tested for use of nocive substances according to Oeko-Tex® Standard 100.

EVENTS & PROMOTIONS

SPORTS & LOUNGE

SCHOOLS & CHILDREN

CORPORATIVE UNIFORMS

HIGH VISIBILITY

WORK CLOTHES

FASHION & BRANDS

**th**<sup>®</sup>  
clothes



TR



REINFORCING SATIN TAPE



## LUANDA



XS - XXL

100% cotton men's jersey tubular T-shirt (150 g/m<sup>2</sup>).  
Colour 83: 90% cotton / 10% viscose. 1x1 rib collar and jersey ribbing. Double stitching on sleeves and bottom.

📏 Sizes: XS, S, M, L, XL, XXL

📏 TRS - 280 x 200 mm

30101



30102



## SOFIA



S - XXL

100% cotton jersey Women's fitted T-shirt (150 g/m<sup>2</sup>).  
Colour 83: 90% cotton / 10% viscose. Slim jersey collar with satin ribbing. Double stitching on sleeves and bottom. Cut and sewn.

📏 Sizes: S, M, L, XL, XXL

📏 TRS - 240 x 200 mm

30105



30106





TR

## ANKARA



100% cotton men's jersey tubular T-shirt (190 g/m<sup>2</sup>).  
 Colour 83: 90% cotton / 10% viscose. 1x1 rib collar and  
 jersey ribbing. Double stitching on sleeves and bottom.  
 ⚙️ Sizes: XS, S, M, L, XL, XXL  
 📏 TRS - 280 x 200 mm

30109 06



## ANKARA WOMEN



100% cotton jersey Women's fitted T-shirt (190 g/m<sup>2</sup>).  
 Colour 83: 90% cotton / 10% viscose. Slim jersey collar  
 with satin ribbing. Double stitching on sleeves and  
 bottom. Cut and sewn.  
 ⚙️ Sizes: S, M, L, XL, XXL  
 📏 TRS - 240 x 200 mm

30113 06





## SAN MARINO



100% cotton pique men's T-shirt (195 g/m<sup>2</sup>). Colour 83: 85% cotton / 15% viscose. Thin 1x1 rib collar. No tag on collar. Cut and sewn. Rib on the sleeve.

📏 Sizes: S, M, L, XL, XXL  
✂️ TRS - 290 x 200 mm

30185 06

30186 03 84 83

## ATHENS



100% cotton jersey men's t-shirt (150 g/m<sup>2</sup>) with tubular shape. Colours 94, 95 and 99: 60% cotton / 40% polyester. Short sleeve. V-neckline. Reinforcement tape. Collar in jersey. Double stitching on sleeves and bottom.

📏 Sizes: S, M, L, XL, XXL  
✂️ TRS - 280 x 200 mm

30115 06

30116 03 34 94 95 99



## ATHENS WOMEN



100% cotton jersey women's T-shirt (150 g/m<sup>2</sup>). Colours 94, 95 and 99: 60% cotton / 40% polyester. This t-shirt has a short sleeve and overlapping V-neck, reinforcement ribbon and a jersey collar. It has double stitching on the sleeves and bottom and is cut and sewn.

📏 Sizes: S, M, L, XL, XXL  
✂️ TRS - 240 x 200 mm

30117 06

30118 03 02 54 94 95 99





## BUCHAREST WOMEN

  S - XXL

100% cotton jersey Women's long-sleeved T-shirt (150 g/m<sup>2</sup>).  
Colours 94, 95 and 99: 60% cotton / 40% polyester. Collar in jersey.  
Double stitching on sleeves and bottom. Cut and sewn.

⚖ Sizes: S, M, L, XL, XXL  
✂ TRS - 290 x 200 mm

30125

06

30126

03

34

05

94

95

99

TR

## BUCHAREST

  S - XXL

100% cotton jersey Men's long sleeve tubular T-shirt  
(150 g/m<sup>2</sup>). Colours 94, 95 and 99: 60% cotton / 40%  
polyester. 1x1 rib collar and jersey ribbing. Double stitching  
on sleeves and bottom.

⚖ Sizes: S, M, L, XL, XXL  
✂ TRS - 290 x 200 mm

30123

06

30124

03

34

05

94

95

99





TR

## IBIZA

 XS - XXL

100% cotton men's jersey sleeveless t-shirt (140 g/m<sup>2</sup>). Colours 94, 95 and 99: 60% cotton / 40% polyester. Colour 83: 90% cotton / 10% viscose. Large armholes. Cut and sewn.

⚖ Sizes: XS, S, M, L, XL, XXL  
✂ TRS - 280 x 200 mm

30121



30122



## TIRANA

 S - XXL

100% cotton jersey women's sleeveless T-shirt (160 g/m<sup>2</sup>) with "T" back. Cut and sewn.

⚖ Sizes: S, M, L, XL, XXL  
✂ TRS - 240 x 200 mm

30119



30120





## NICOSIA

  S - XXL

Men's technical t-shirt, 100% polyester jersey (125 g/m<sup>2</sup>). Short sleeve. Reinforcement tape on the collar. Double stitching on sleeves and bottom.

☒ Sizes: S, M, L, XL, XXL  
✂ TRS - 280 x 200 mm

30192



30127



TR

## NICOSIA WOMEN

  S - XXL

100% polyester women's technical t-shirt (125 g/m<sup>2</sup>), slightly fitted. Short sleeve. Reinforcement tape on the collar. Double stitching on sleeves and bottom.

☒ Sizes: S, M, L, XL, XXL  
✂ TRS - 240 x 200 mm

30193



30128





## EVE



S - XXL

100% cotton pique women's fitted polo (195 g/m<sup>2</sup>). Colour 83: 85% cotton / 15% viscose. Rib collar and sleeves. Reinforcement tape on the collar. Reinforced placket with 4 coloured buttons. Extra button on inner seam. Cut and sewn.

📏 Sizes: S, M, L, XL, XXL

📏 TRS - 240 x 200 mm

30134



30135



## ADAM



S - XXL

100% cotton pique men's polo (195 g/m<sup>2</sup>). Colour 83: 85% cotton / 15% viscose. This polo has a rib collar and sleeves, reinforcement on the collar and 3 coloured buttons. The bottom has side openings and has an extra button on the inner seam. It is cut and sewn.

📏 Sizes: S, M, L, XL, XXL

📏 TRS - 280 x 200 mm

30130



30131



## BERLIN



65% polyester and 35% cotton Men's polo shirt (200 g/m<sup>2</sup>). Rib collar and sleeves. Reinforcement tape on collar and placket reinforced with 3 coloured buttons. Extra button on inner seam. Cut and sewn.

📏 Sizes: S, M, L, XL, XXL  
✂️ TRS - 280 x 200 mm

30175



30176



HIGH WEIGHT:  
240 g/m<sup>2</sup>



REMOVABLE  
VISIBLE LABEL

## MONACO



100% cotton pique men's polo (240 g/m<sup>2</sup>). Colour 83: 85% cotton / 15% viscose. Rib collar and sleeves, rib reinforcement on collar and placket reinforced with 3 coloured buttons. Bottom with side openings. Extra button on inner seam. Cut and sewn.

📏 Sizes: S, M, L, XL, XXL  
✂️ TRS - 290 x 200 mm

30187



30188



## DHAKA



100% cotton pique men's polo (195 g/m<sup>2</sup>). Colour 83: 85% cotton / 15% viscose. Rib collar and sleeves, rib reinforcement on collar and placket reinforced with 2 coloured buttons. Bottom with side openings. Extra button on inner seam. Cut and sewn. Jetted pocket.

📏 Sizes: S, M, L, XL, XXL  
✂️ TXP - 100 x 60 mm

30209



30208







## ROME WOMEN



100% cotton pique women's slim fit polo (195 g/m<sup>2</sup>) side openings. Colour 83: 85% cotton / 15% viscose. Short sleeve. Rib collar and sleeves. Two-colour contrast on collar, placket and sleeve. Reinforced placket. Extra button on inner seam.

📏 Sizes: S, M, L, XL, XXL

📏 TRS - 240 x 200 mm

30138



30139

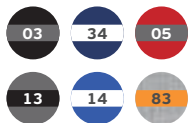

## ROME



100% cotton pique men's slim fit polo (195 g/m<sup>2</sup>) with slim fit and side openings. Colour 83: 85% cotton / 15% viscose. Short sleeve. Rib collar and sleeves. Two-Colour contrast on collar, placket and sleeve. Reinforced placket. Extra button on inner seam.

📏 Sizes: S, M, L, XL, XXL

📏 TRS - 290 x 200 mm

30136



30137





## BERN WOMEN



100% cotton pique women's long sleeve polo (210 g/m<sup>2</sup>). Colour 83: 85% cotton / 15% viscose. Rib collar and cuffs, rib reinforcement on collar and placket reinforced with 4 coloured buttons. Bottom with side openings. Extra button on inner seam. Cut and sewn.

📏 Sizes: S, M, L, XL, XXL  
✂️ TRS - 240 x 200 mm

30144

06

30145

15

03

34

05

14

02

83

TR

## BERN



100% cotton pique men's long-sleeved polo (210 g/m<sup>2</sup>). Colour 83: 85% cotton / 15% viscose. Rib collar and cuffs, rib reinforcement on collar and placket reinforced with 3 coloured buttons. Bottom with side openings. Substitute button on inner seam. Cut and sewn.

📏 Sizes: S, M, L, XL, XXL  
✂️ TRS - 290 x 200 mm

30140

06

30141

15

03

34

05

13

28

14

11

19

83





## MILAN WOMEN

  S - XXL

Women's V-neck pullover in 70% cotton and 30% polyamide (220 g/m<sup>2</sup>). Rib cuffs and bottom. Sleeves inserted with fully-fashion.

📏 Sizes: S, M, L, XL, XXL  
📏 EDB - 280 x 200 mm

30150

15

03

34

93

## MILAN

  S - XXL

Men's V-neck pullover in 70% cotton and 30% polyamide (220 g/m<sup>2</sup>). Rib cuffs and bottom. Sleeves inserted with fully-fashion.

📏 Sizes: S, M, L, XL, XXL  
📏 EDB - 290 x 200 mm

30149

15

03

34

93



## MILAN RN

  S - XXL

Men's round neck pullover in 70% cotton and 30% polyamide (220 g/m<sup>2</sup>). Rib cuffs and bottom. Sleeves inserted with fully-fashion.

📏 Sizes: S, M, L, XL, XXL  
📏 EDB - 290 x 200 mm

30210

03

34

93





## BATALHA

  S - XXL

Poplin men's shirt in 35% cotton and 65% polyester (115 g/m<sup>2</sup>). Long sleeve. Invisible button for firmness of the collar. Placket with 7 coloured buttons. Adjustable cuffs with 2 buttons.

📏 Sizes: S, M, L, XL, XXL  
✂️ TRS - 80 x 40 mm

30212



30211



TR

## BATALHA WOMEN

  S - XXL

Poplin women's shirt in 35% cotton and 65% polyester (115 g/m<sup>2</sup>). Long sleeve. Invisible button for firmness of the collar. Fitted cut. Placket with 7 coloured button. 2 pleats on the back.

📏 Sizes: S, M, L, XL, XXL  
✂️ TRS - 80 x 40 mm

30214



30213





## LONDON

  S - XXL

Men's oxford shirt in 70% cotton and 30% polyester (130 g/m<sup>2</sup>). Short sleeve. Left side pocket. Collar with 2 buttons. Placket with 7 pearl buttons.

📏 Sizes: S, M, L, XL, XXL  
✂️ TRS - 80 x 40 mm

30200 

30157 

## TOKYO

  S - XXL

Men's oxford shirt in 70% cotton and 30% polyester (130 g/m<sup>2</sup>). Long sleeve. Left side pocket. Collar with 2 buttons. Adjustable 2-button cuffs and 7-button placket.

📏 Sizes: S, M, L, XL, XXL  
✂️ TRS - 80 x 40 mm

30196 

30153  



## PARIS

  S - XXL

Men's poplin shirt made of 68% cotton, 28% polyamide and 4% elastane (115 g/m<sup>2</sup>). Long sleeve. Fitted cut. Placket with 7 coloured buttons. Adjustable cuffs with 2 buttons.

📏 Sizes: S, M, L, XL, XXL  
✂️ TRS - 80 x 40 mm

30194 

30151  



## LONDON WOMEN

  S - XXL

Women's oxford shirt in 70% cotton and 30% polyester (130 g/m<sup>2</sup>). Short sleeve. Fitted cut. Placket with 7 pearl buttons. 2 pleats on the back and front.

☒ Sizes: S, M, L, XL, XXL  
✂ TRS - 80 x 40 mm

30201

06

30158

24



## TOKYO WOMEN

  S - XXL

Women's oxford shirt in 70% cotton and 30% polyester (130 g/m<sup>2</sup>). Long sleeve. Girdle cut. Adjustable 2-button cuffs and 7-button placket. 2 pleats on the back and front.

☒ Sizes: S, M, L, XL, XXL  
✂ TRS - 80 x 40 mm

30197

06

30154

24

## PARIS WOMEN

  S - XXL

Women's poplin shirt in 68% cotton, 28% polyamide and 4% elastane (115 g/m<sup>2</sup>). Long sleeve. Fitted cut. Placket with 7 coloured buttons. Adjustable cuffs with 2 buttons. 2 pleats on the back.

☒ Sizes: S, M, L, XL, XXL  
✂ TRS - 80 x 40 mm

30195

06

30152

03



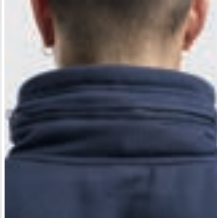



## VILNIUS

  XS - XXL

Unisex hooded sweatshirt. 50% cotton and 50% polyester: 320 g/m<sup>2</sup>. With turtleneck and taffeta hood embedded in the collar (with plastic closure). Rib 1x1 at the wrists and waistband. 2 pockets with plastic closure.

 Sizes: XS, S, M, L, XL, XXL

 TRS - 280 x 200 mm

30253

03

34

68

83

## DELTA

  S - XXL

Unisex sweatshirt in 50% cotton and 50% polyester (300 g/m<sup>2</sup>). Carded interior. 1x1 rib and double stitching on collar, cuffs and waistband. Reinforcement tape on the collar.

 Sizes: S, M, L, XL, XXL

 TRS - 290 x 200 mm

30202

06

30159

15

03

34

05

13

09

28

14

49

29

83



## BUDAPEST

  S - XXL

Unisex sweatshirt in 50% cotton and 50% polyester (320 g/m<sup>2</sup>). Carded interior. With 1/4 zip in colour.

 Sizes: S, M, L, XL, XXL

 TRS - 90 x 60 mm

30163

03

34

94

73

83

## VIENNA



100% polyester unisex fleece (280 g/m<sup>2</sup>). With 1/4 zip closure.  
Elastic band on sleeves.  
📏 Sizes: S, M, L, XL, XXL  
✂️ EDB - 100 x 60 mm

30166



## HELSINKI WOMEN



Women's fleece jacket in 100% polyester closure: 280 g/m<sup>2</sup>. coloured zip.  
Side pockets. Elastic band on the sleeves. Fitted cut.  
📏 Sizes: S, M, L, XL, XXL  
✂️ EDB - 100 x 60 mm

30205



30165



## HELSINKI



Men's fleece jacket with zip. 100% polyester (280 g/m<sup>2</sup>). Coloured zip.  
Side pockets. Elastic band on the sleeves.  
📏 Sizes: S, M, L, XL, XXL  
✂️ EDB - 100 x 60 mm

30204



30164



TR





## AMSTERDAM



S - XXL

Men's zip-up hooded sweatshirt in 50% cotton 50% polyester zip-up hooded sweatshirt (320g/m<sup>2</sup>). Hood lined with drawstring. Carded interior. 2 marsupial pockets. Plastic closure with cover.

📏 Sizes: S, M, L, XL, XXL

✂️ TRS - 100 x 60 mm

30161

03

34

05

94

95

83

## AMSTERDAM WOMEN



S - XXL

Women's sweatshirt with zip and hood in 50% cotton and 50% polyester (320 g/m<sup>2</sup>). Hood lined with drawstring. Carded interior. 2 marsupial pockets. Plastic closure with cover.

📏 Sizes: S, M, L, XL, XXL

✂️ TRS - 100 x 60 mm

30162

03

34

94

95

83





## PHOENIX

  XS - XXL

Unisex hooded sweatshirt in 50% cotton and 50% polyester (320 g/m<sup>2</sup>). Carded interior. Rib 1x1 at the wrists and waistband. Marsupial pocket, hood with eyelets and coloured drawstring cord.

 Sizes: XS, S, M, L, XL, XXL  
 TRS - 290 x 200 mm

30203

06

30160

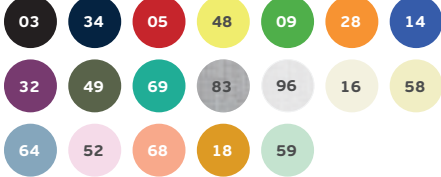



TR

## MOSCOW

  S - XXL

Unisex sweatshirt in 50% cotton and 50% polyester (320 g/m<sup>2</sup>). Carded interior. Rib 1x1 at the wrists and waistband. Marsupial pocket. Hood and drawstrings in contrast colour.

 Sizes: S, M, L, XL, XXL  
 TRS - 280 x 200 mm

30207

06

30189



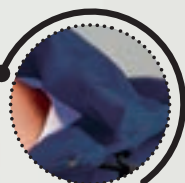

MESH LINED HOOD

## DUBLIN

  XS - XXL

100% polyester taffeta unisex windbreaker (65 g/m<sup>2</sup>). Hood with stoppers and mesh lining. Side pockets with plastic closure. Clamping elastic with stoppers at the bottom part.

⚖ Sizes: XS, S, M, L, XL, XXL

✂ TXP - 80 x 40 mm

30190



## OPORTO

  S - XXL

Men's sports jacket in 100% polyester (160 g/m<sup>2</sup>). 2 front pockets. Cuffs and waistband in bicolour material. 1 back pocket for easy customisation.

⚖ Sizes: S, M, L, XL, XXL

✂ TXP - 290 x 200 mm

30215



## LIUBLIANA

  XS - XXL

Padded unisex parka. 100% polyester pongee 240 exterior and waterproof PVC coating. 100% polyester taffeta interior. Filling: polyester (80 g/m<sup>2</sup>). Collar lined in black polar mesh (closes with velcro strap). Foldable hood on the collar, adjustable via black stoppers. Flap opening, coloured zipper, velcro and black spring buttons. 2 outer pockets with flap and 2 inner pockets (1 for mobile phone) with velcro closure. 2x2 ribbed inner cuffs. Adjustable outer cuffs with velcro straps. Heat sealed seams. Zippered lower back access for easy customisation.

⚖ Sizes: XS, S, M, L, XL, XXL

✂ EDB - 90 x 60 mm

30183







## SKOPJE

  S - XXL

Men's hooded jacket. Polyester 300T (95% polyester and 5% spandex): 150 g/m<sup>2</sup>. Hood with stoppers. Interior pockets. Area above the chest for easy customisation.

 Sizes: S, M, L, XL, XXL  
 TRS - 280 x 200 mm

30246

03



34

TR

## BRUSSELS

  S - XXL

Padded unisex parka. 100% polyester. With interior pockets and elastic cuffs. Waterproof zippers.

 Sizes: S, M, L, XL, XXL  

30254

03

34





## ZAGREB WOMEN



Women's softshell jacket with removable hood in 96% polyester and 4% elastane (280 g/m<sup>2</sup>). Water repellent coating (class III). Lined with polar mesh. 2 front zipped pockets. Diagonal chest pocket with zip. Adjustable cuffs with velcro strap. Removable hood with drawstring and velcro strap to fit the collar. Rounded in the lower back. Fitted cut.

📏 Sizes: S, M, L, XL, XXL  
 📐 TRS - 100 x 60 mm

30181



## ZAGREB



Men's softshell jacket, with removable hood in 96% polyester and 4% elastane (280 g/m<sup>2</sup>). Water repellent coating (class III). Lined with polar mesh. 2 front zipped pockets. Diagonal chest pocket with zip. Adjustable cuffs with velcro strap. Removable hood with drawstring and velcro strap to fit the collar. Rounded in the lower back.

📏 Sizes: S, M, L, XL, XXL  
 📐 TRS - 100 x 60 mm

30180





## BAKU

  S - 3XL

Unisex softshell vest. 96% polyester and 4% spandex (2 layers): 280 g/m<sup>2</sup>. Windproof. Water repellent coating. 3 pockets: simple chest pocket and 2 zipped pockets. Lower back longer than the front. Easy access customisation area.

 Sizes: S, M, L, XL, XXL, 3XL

 TRS - 100 x 80 mm

30252

03

34

13

TR

## STOCKHOLM

  S - 3XL

Padded work vest with 100% polyester lining and collar lined with polar mesh. 6 pockets: 5 front, including 2 with zippers inserted and 1 for mobile phone. 1 inside pocket. Side elastic for better fit to the body. Zipped lower back access for easy customisation.

 Sizes: S, M, L, XL, XXL, 3XL

 TRS - 70 x 25 mm

30177

03

34

13





## MINSK

  S - 3XL

Unisex workwear smock. 20% cotton and 80% polyester: 190 g/m<sup>2</sup>. Stylized collar. Sleek and stylish cut with 2 side pockets. Elastic cuffs. Closes with snap buttons. Back opening for better freedom of movement.

☒ Sizes: S, M, L, XL, XXL, 3XL  
✂ TRS - 280 x 70 mm

30250 

30249    

## ZAGREB WORK

  S - XXL

100% polyester men's high-visibility softshell jacket (320 g/m<sup>2</sup>). Water repellent coating (class III). Lined with polar mesh. TPU coating. 2 front zipped pockets. Diagonal chest pocket with zip. Adjustable cuffs with velcro strap. Removable hood with drawstring and velcro strap to fit the collar. Rounded in the lower back.

☒ Sizes: S, M, L, XL, XXL  
✂ TRS - 290 x 200 mm

30182 



## WARSAW

  XS - XXL

80% cotton and 20% polyester men's work pants (250 g/m<sup>2</sup>). 8 pockets. Reflective finishes in the front. 3 pockets with velcro closure. Front pocket suitable for mobile phone. Oxford slots for knee pads. Elastic Waist. Plastic waistband.

☒ Sizes: XS, S, M, L, XL, XXL  
✂ TRS - 90 x 60 mm

30178   

## BRATISLAVA

 ♂ S - 3XL

Men's workwear jacket. 98% cotton and 2% spandex: 240 g/m<sup>2</sup>. Stylized collar. 2 side pockets and 1 chest pocket. Partial elastic at cuffs and waist. Closes with snap buttons. 2 pleats on the back.

📏 Sizes: S, M, L, XL, XXL, 3XL

📏 TXP - 80 x 80 mm

30248

03

34

13

11



## TALLINN

 ♂ S - 3XL

Men's workwear trousers. 98% cotton and 2% spandex: 240 g/m<sup>2</sup>. 6 pockets: 2 side zipped pockets, 2 front pockets and 2 back pockets. Waist with elastic on the sides. Slim fit cut.

📏 Sizes: S, M, L, XL, XXL, 3XL

📏 TRS - 80 x 80 mm

30247

03

34

13

11

TR

## ASTANA

 ♀ S - 3XL

Unisex padded workwear jacket. 100% polyester. Convertible to vest with removable zippered sleeves. Collar lined with polar mesh. 3 zip pockets. Zippered access at the back for easy customisation.

📏 Sizes: S, M, L, XL, XXL, 3XL

📏 TRS - 280 x 200 mm

30251

03

34

13







HOOD  
ACCORDING  
TO EUROPEAN  
UNION SAFETY  
STANDARDS

## PHOENIX KIDS

  2 - 12

Unisex Kids Hooded Sweatshirt, 50% cotton and 50% polyester (320 g/m<sup>2</sup>). Carded interior. Rib 1x1 at the wrists and waistband. Marsupial pocket. Jersey-lined hood complying with European Union safety standards.

📏 Sizes: 2, 4, 6, 8, 10, 12  
✂️ TRS - 200 x 200 mm

30206 

30174     

## DUBLIN KIDS

  6 - 14

100% polyester taffeta windbreaker (65 g/m<sup>2</sup>). Hood lined with net. Side pockets with plastic closure. Clamping elastic with stoppers at the bottom part.

📏 Sizes: 6, 8, 10, 12, 14  
✂️ TXP - 80 x 40 mm

30191      



REMOVABLE  
VISIBLE LABEL

## QUITO



2 - 12

100% cotton jersey unisex kid's t-shirt (150 g/m<sup>2</sup>). 1x1 rib collar and jersey ribbing. Double stitching on sleeves and bottom. Cut and sewn.

☞ Sizes: 2, 4, 6, 8, 10, 12

✂ TRS - 200 x 200 mm

30168



30169

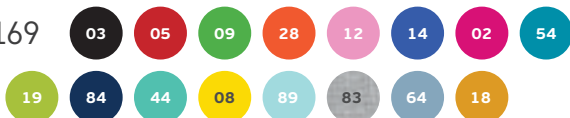

## ANKARA KIDS



2 - 12

100% cotton jersey unisex kid's t-shirt (190 g/m<sup>2</sup>). 1x1 rib collar and jersey ribbing. Double stitching on sleeves and bottom. Cut and sewn.

☞ Sizes: 2, 4, 6, 8, 10, 12

✂ TRS - 200 x 200 mm

30170



30171

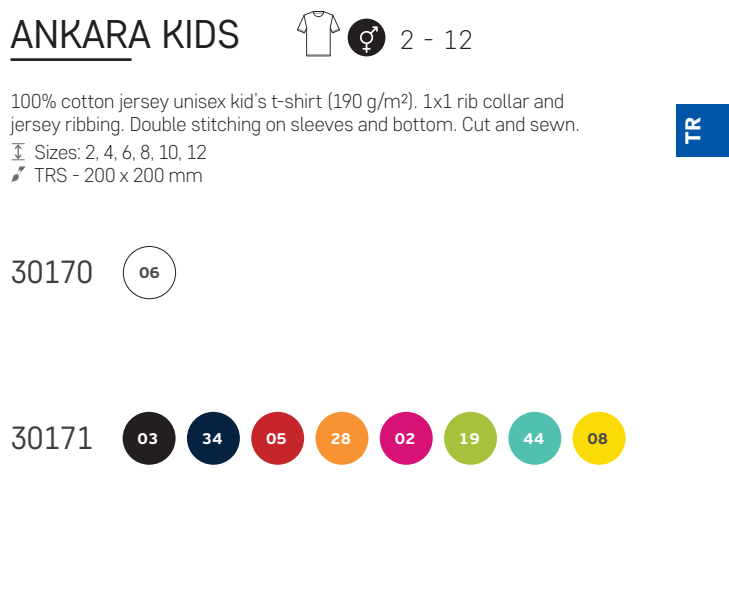

## ADAM KIDS



2 - 12

100% cotton pique unisex children's polo (195 g/m<sup>2</sup>). This polo has rib collar and sleeves, rib reinforcement at collar, reinforced placket with 3 coloured buttons, bottom with side openings and extra button at the inner seam. Cut and sewn. Cut and sewn.

☞ Sizes: 2, 4, 6, 8, 10, 12

✂ TRS - 200 x 200 mm

30172



30173



TR

MADE IN EUROPE SERVICES

ORIGINAL  
LANYARDS®

3D PRINT'IN

PAPER'IN

GRAPHIC'IN

BUTTON P'IN

DOM'ING

DIRECT IMPORT SERVICES FROM ASIA

connecting  
USB you

connecting  
LANYARD you

connecting  
BOTTLE you



## 1 MODEL

Choose our Tube, Sublimation, Nautic, Cork or Leather models

## 2 SIZE

Choose size, thickness or width depending on your Original Lanyards® model



## 3 COLOR

Choose from one of the standard colours in stock or a Pantone® colour of your choice according to your Original Lanyards® model

## 4 ACCESSORIES

- **Elastic** - Choose the colour of the elastic and create different combinations from more than 8 colours available or choose a colour to suit your needs



- **Label** - Choose your favourite label and customise it with your logo



Rubber label



Polyester



Polyester Jacquard



Cotton



Cotton Jacquard

2 sizes available: 43 x 22 mm and 43 x 15 mm (except on rubber labels)

- **Zips** - Finish your lanyard with our offers of rings or carabiners



# TUBE

**- DIMENSIONS**

Short (ø8 x 175 mm)  
Long (ø8 x 470 mm)



**- COLOR**

More than 20 standard colours



Pantone® colours available

**- ACCESSORIES**

**Elastic**



8 standard colours



Pantone® colours available

**Labels**



Rubber label



Polyester



Polyester  
Jacquard



Cotton

**Zips**



Ring or Carabiner

**Extras**



Security lock



**DELIVERY TIME:**  
Standard: from 8 business days  
Special: from 16 business days



**MOQ:**  
Standard: No minimum order quantity  
Special: 200 pieces

# NAUTIC

**- DIMENSIONS**

Short (ø6 x 175 mm)  
Long (ø6 x 470 mm)

**- COLOR**

More than 10 standard colours



Pantone® colours available



**- ACCESSORIES**

**Elastic**



8 standard colours



Pantone® colours available

**Labels**



Rubber label



Polyester



Polyester  
Jacquard



Cotton

**Zips**



Ring or Carabiner

**Extras**



Security lock



**DELIVERY TIME:**  
Standard: from 8 business days  
Special: from 16 business days



**MOQ:**  
Standard: No minimum order quantity  
Special: 200 pieces

# SUBLIMATION

## - DIMENSIONS

Thin (15 x 470 mm)  
Large (20 x 470 mm)

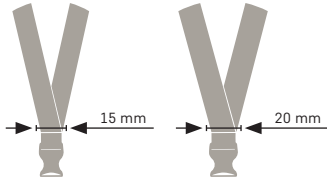

## - COLOR

Sublimation printing  
available in CMYK

## - ACCESSORIES

### Zips



Ring or Carabiner



DELIVERY TIME:  
from 8 business days



NO MINIMUM ORDER QUANTITY

# CORK

**- DIMENSIONS**

Thin (ø3 mm) or Large (ø5 mm)  
Short (175 mm) or long (470 mm)

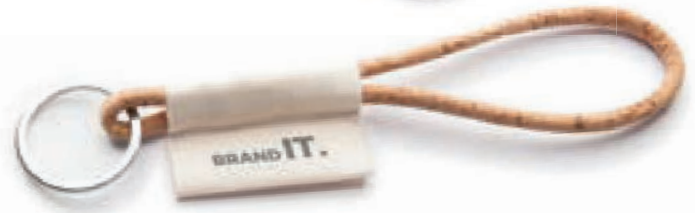
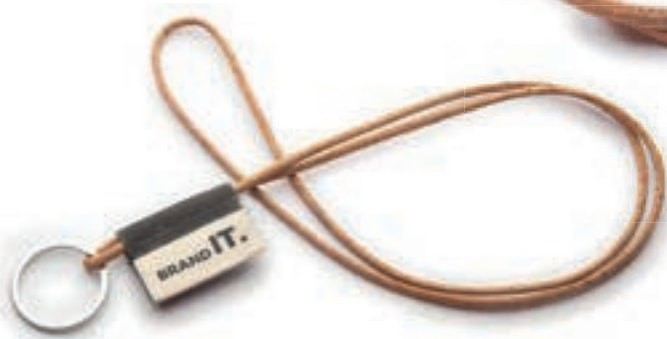

**- ACCESSORIES**

**Elastic**



8 standard colours



Pantone® colours available

**Zips**



Ring or Carabiner

**Labels**



Rubber label



Polyester



Polyester  
Jacquard



Cotton

**Extras**



Security lock



**DELIVERY TIME:**  
Standard: from 8 business days  
Special: from 16 business days



**MOQ:**  
Standard: No minimum order quantity  
Special: 200 pieces



# LEATHER

- DIMENSIONS

Short (10 x 200 mm)  
Long (10 x 500 mm)

- COLOR

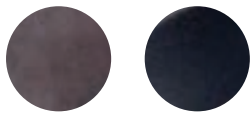

Brown or black leather



- ACCESSORIES

Zips



Ring or Carabiner

Customisation



In stamp



DELIVERY TIME:  
from 10 business days



NO MINIMUM ORDER QUANTITY



## 1 INNOVATIVE AND CREATIVE SERVICE

- Send us your drawings, we can turn it into your 3D project
- Choose a complementary product to the offer in the hi!dea catalogue
- Choose a template created by us and put your logo on it

## 2 MULTIPLE COLOURS AVAILABLE



Tell us the colour that suits your brand

- Choose from more than 25 colours available
- Combine up to 2 colours per product

## 3 3-DIMENSIONAL PRINTS

Depending on the model you choose, we can offer you quality 3D prints

## 4 FINAL RESULT

A unique, customised product, personalized with your brand and with the stamp Made in Europe

### MATERIAL

- Biodegradable
- Recyclable
- Naturally occurring
- No additives
- Polymer 100% PLA



DELIVERY TIME:  
from 7 business days



NO MINIMUM ORDER QUANTITY

## YOUR BRAND IN 3 DIMENSIONS



5

## ILLUSTRATIVE TECHNICAL DRAWING OF THE PROCESS

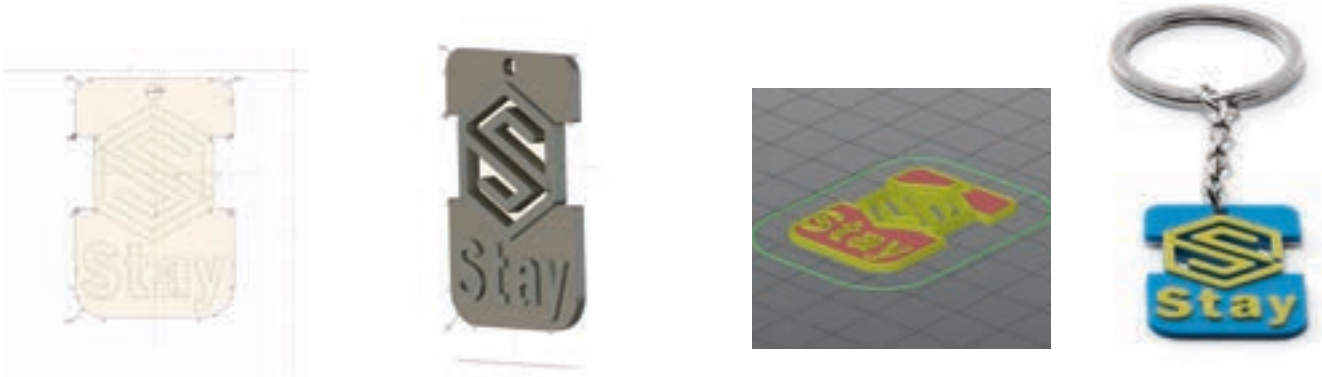

Two-dimensional model

Three-dimensional model

Sliced model

Final model



## 100% CREATIVE

PUT YOUR BRAND ON ONE OF THE SEVERAL MODELS AVAILABLE



Customisable ballpoint pens. Send us your text.  
A unique and personalized offer.

TRANSFORM THE PRODUCTS FROM THE HI!DEA COLLECTION WITH YOUR BRAND PRINTED IN 3D



## DIY

SEND US YOUR 3D DESIGN AND WE WILL EXECUTE YOUR PROJECT



1

ILLUSTRATIVE TECHNICAL DRAWING OF THE PROCESS

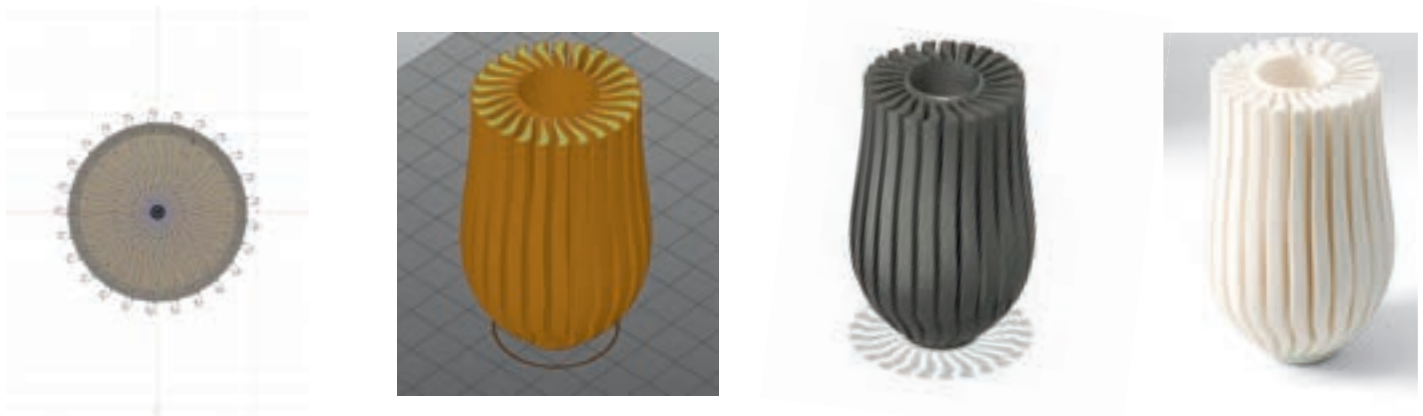

Two-dimensional model

Sliced model

Three-dimensional model

Final model





12

## HOW TO ORDER YOUR PAPER'IN BAG:

### 1 MODELS

Choose the model of the bag that suits your brand best:

### 2 MATERIAL

Material of your bag:  
Paper coated matte 170 gsm  
Shiny lamination  
Cardboard base

### 3 CUSTOMISATION

Choose one of the customisation types:



CMYK printing

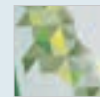

UV Varnish

### 4 HANDLES

Choose a cotton rope or a polyester ribbon for the handle of your bag:

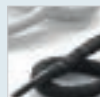

Standard handles



Polyester ribbons

Other colours upon request

### 5 RESULT

A bag totally created by you!



DELIVERY TIME:  
from 15 business days



MOQ:  
500 pieces

## MODEL



### 72888 / 72898

Bag.  
72888: 415 x 320 x 140 mm  
72898: 320 x 420 x 120 mm  
Rope - 350 x 6 mm



### 72887 / 72897

Bag.  
72887: 250 x 250 x 80 mm  
72897: 320 x 420 x 120 mm  
Rope - 300 x 6 mm



### 72899

Bag.  
100 x 380 x 100 mm  
Rope - 300 x 6 mm



### 72886 / 72896

Bag.  
72886: 248 x 198 x 88 mm  
72896: 180 x 230 x 80 mm  
Rope - 300 x 6 mm



## FOLDERS WITH FLAP



## FOLDERS WITHOUT FLAP



### SIZE



310 x 450 mm

### TYPE OF PAPER



350g Couché

### FINISHING



Matte plastification



Shiny plastification



### DELIVERY TIME:

Folders with flap: from 9 business days  
Folders without flap: from 8 business days



MOQ:  
250 pieces



INVITATIONS



SIZE

 210 x 100 mm

TYPE OF PAPER

 300g Couché

FINISHING

 Matte plastification

 Shiny plastification

 Offset Varnish

 DELIVERY TIME:  
from 8 business days

 MOQ:  
100 pieces

## CARDS



Business cards

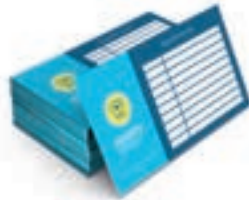

Scheduling Cards



Loyalty Cards

### TYPE OF PAPER

 315g CLA Carton

 300g Couché

### SIZE

 **STANDARD** Standard format (85 x 55 mm)

 **DELIVERY TIME:** from 8 business days

### CORNERS

 Rectangular corners

 Rounded corners

 **MOQ:** 100 pieces

### FINISHING

 Matte plastification

 Shiny plastification

 Offset Varnish

## FLYERS AND DIPTYCHS



Front only



Front and back



Diptychs

### SIZE

 210 x 297 mm

 148 x 210 mm

 105 x 148 mm

### TYPE OF PAPER

 90g Matte Couché

 125g Shiny Couché

 300g Couché

 **DELIVERY TIME:** from 8 business days

 **MOQ:** 100 pieces

### FINISHING

 Matte plastification

 Shiny plastification

 Offset Varnish

## ROLL-UPS



Roll-up (click clack)  
850 x 2000 mm

### MATERIAL



Semi Gloss Canvas 340g



DELIVERY TIME:  
from 8 business days

## L-BANNERS



L-banner (standard)  
800 x 2000 mm

### TYPE OF PRINTING



Digital



NO MINIMUM QUANTITIES

## ADVERTISING BANNERS



### DROP SIZE

790 x 1740 mm  
1040 x 2350 mm  
1290 x 2980 mm



### CANDLE SIZE

580 x 2080 mm  
681 x 2680 mm  
860 x 3480 mm



### KNIFE SIZE

630 x 1740 mm  
681 x 2680 mm  
870 x 3480 mm

### MATERIAL



Resistant and durable windproof fabric

### EXTRAS



Spike base



Small cross base



Big cross base



Float for cross base



Spike sand base



Base for car



DELIVERY TIME:  
from 9 business days



NO MINIMUM QUANTITIES



## MODEL

### RECTANGULAR

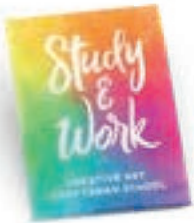

53 x 78 mm  
vertical



78 x 53 mm  
horizontal

### ACCESSORIES



Pin



Magnet

### ROUND



Ø25 mm



Ø38 mm



Ø50 mm



Ø59 mm

### ACCESSORIES



Pin

Ø25 mm | Ø38 mm  
Ø50 mm | Ø59 mm



Magnetic clasp

Ø38 mm



Double magnetic  
clasp

Ø50 mm | Ø59 mm



Bottle opener  
with magnet

Ø59 mm



Magnet

Ø25 mm | Ø38 mm  
Ø50 mm | Ø59 mm



12

## HOW TO ORDER YOUR DOM'ING:

### 1 MODEL

Choose between pins or keyrings.  
Choose round, square, rectangular  
or create a special format for you

### 2 ACCESSORIES

Choose accessories  
and colours

### 3 PRINTING

Your logo will be printed  
in full colour (CMYK)

### 4 RESULT

A pin or keyring totally  
created by you!



DELIVERY TIME:  
from 8 business days



MOQ:  
250 pieces

**FLEXIBLE PINS**

**MODEL**



**ROUND**

- Ø15 mm
- Ø20 mm
- Ø25 mm
- Ø30 mm



**SQUARE**

- 15 x 15 mm
- 20 x 20 mm
- 25 x 25 mm



**RECTANGULAR**

- 25 x 15 mm
- 35 x 12 mm
- 35 x 20 mm



**SPECIAL FORMATS**

From 3 to 7 cm<sup>2</sup>

**COLOUR PIN**



Golden



Silver

**SUPPORT PINS**

**MODEL**



Ø18 mm



19 x 15 mm



20 x 18 mm

**SUPPORT COLOUR**



Golden



Silver

**KEYRINGS**

**SPECIAL FORMATS**

From 9 to 18 cm<sup>2</sup>





5

### HOW TO ORDER YOUR CONNECTINGYOU USB:

#### 1 MODEL

Choose one of the 45 available USB models.

#### 2 CAPACITY

Choose your capacity from 1 up to 32 GB.

#### 3 CUSTOMISATION

Choose one of the 7 printing techniques available. Includes a 2 colour 1 position print or laser engraving 1 position.

#### 4 EXTRAS

Choose one of the 9 special gift boxes. Includes individual standard box.

#### 5 RESULT

A USB totally created by you!

### CHARACTERISTICS



Interface USB 2.0 and 3.0 (available with selected models).



RoHS ROHS compliant



DELIVERY TIME:  
from 13 business days (ref. 77630)  
15 business days (other models)



MOQ:  
100 pieces per model/colour,  
except for reference 77700





**77432**

USB flash drive.  
☞ 42 x 22 x 9 mm



**77506**

UDP flash drive. Aluminium. Any Pantone® colour starting at 1.000 pcs.  
☞ 57 x 24 x 3 mm



**77591**

UDP flash drive.  
☞ 62 x 29 x 4 mm

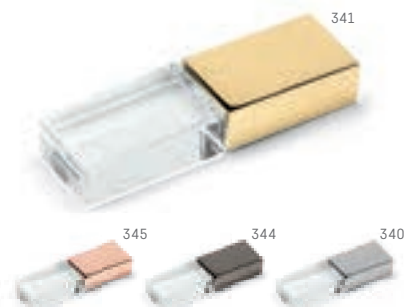

**77595**

UDP flash drive.  
☞ 60 x 18 x 10 mm



**77505**

USB flash drive. Imitation leather. With carabiner clip. Any Pantone® colour starting at 1.000 pcs.  
☞ 100 x 26 x 11 mm



**77501**

USB flash drive. Imitation leather. Any Pantone® colour starting at 500 pcs.  
☞ 73 x 33 x 14 mm



**77523**

USB flash drive. Imitation leather. Any Pantone® colour starting at 500 pcs.  
☞ 80 x 21 x 16 mm



**77435**

USB flash drive. Papier kraft.  
± 019 x 66 mm



**77689**

USB flash drive. Cork.  
± 022 x 49 mm



**77508**

USB flash drive. Available woods: maple, walnut and bamboo.  
± 59 x 19 x 12 mm



**77681**

USB flash drive. Available woods: maple, walnut and bamboo.  
± 60 x 19 x 10 mm



**77696**

USB flash drive. Recycled plastic. Any Pantone® colour starting at 1.000 pcs.  
± 53 x 19 x 6 mm



**77509**

UDP flash drive card. Available woods: maple, walnut and bamboo.  
± 90 x 53 x 5 mm



**77692**

UDP flash drive card.  
± 86 x 54 x 2 mm



**77695**

UDP flash drive card.  
± 86 x 54 x 3 mm



**77610**

Box for USB flash drive. Transparent PP, with magnet. Sold only with USB flash drive.  
± 103 x 72 x 10 mm



**77673**

Mini UDP flash drive. Aluminium. Any Pantone® colour starting at 500 pcs.  
 ㊦ 33 x 12 x 6 mm



**77436**

USB flash drive. Metal.  
 ㊦ 50 x 12 x 7 mm



**77562**

Mini UDP flash drive. Aluminium.  
 ㊦ 12 x 37 x 5 mm



**77504**

Mini UDP flash drive.  
 ㊦ 39 x 15 x 7 mm



**77503**

Mini UDP flash drive. Metal. With carabiner clip.  
 ㊦ 51 x 12 x 5 mm



**77559**

USB flash drive. Any Pantone® colour starting at 1.000 pcs.  
 ㊦ 57 x 17 x 7 mm



**77518**

USB flash drive. With micro USB. Any Pantone® colour starting at 250 pcs.  
 ㊦ 70 x 17 x 8 mm



**77502**

USB flash drive. Stainless steel and ABS. With carabiner clip. Any Pantone® colour starting at 1.000 pcs.  
 ㊦ 61 x 18 x 9 mm



**77434**

USB flash drive. Metal. LED. Laser customisation.  
 ㊦ 58 x 23 x 12 mm





**77515**

USB ball pen flash drive. Black ink ball pen. Any Pantone® colour starting at 500 pcs.  
 134 x 17 x 15 mm



**77500**

UDP ball pen flash drive. Black ink ball pen. Any Pantone® colour starting at 1.000 pcs.  
 Ø14 x 135 mm



**77513**

UDP ball pen flash drive. Black ink ball pen and touch tip.  
 Ø14 x 136 mm



**77603**

Box for USB flash drive. Bamboo. Sold only with USB flash drive.  
 80 x 51 x 25 mm



**77604**

Box for USB flash drive. Recycled cardboard. Sold only with USB flash drive.  
 91 x 40 x 23 mm



**77601**

Box for USB flash drive. PP. Sold only with USB flash drive.  
 68 x 25 x 15 mm



**77602**

Box for USB flash drive. ABS. With PE window. Sold only with USB flash drive.  
 89 x 89 x 20 mm



**77618**

Box for USB flash drive. Metal. Sold only with USB flash drive.  
 115 x 85 x 22 mm



**77614**

Box for USB flash drive. Transparent PP, with magnet. Sold only with USB flash drive.  
 95 x 46 x 21 mm



**77516**

USB flash drive. Interface 3.0.  
Clip: chrome.  
Body: any Pantone® colour.  
± 58 x 18 x 10 mm



**77560**

USB flash drive. Clip: any Pantone® colour starting at 1.000 pcs.  
Body: any Pantone® colour.  
± 58 x 18 x 10 mm



**77630**



USB flash drive. Clip: chrome.  
Body: any Pantone® colour.  
± 58 x 18 x 10 mm

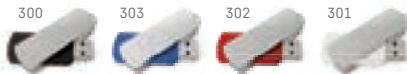

**77688**

USB flash drive. Any Pantone® colour.  
± 55 x 17 x 10 mm



**77561**

USB flash drive. Clip: chrome.  
Body: any Pantone® colour.  
± 58 x 18 x 10 mm



**77664**

USB flash drive bracelet. Any Pantone® colour starting at 250 pcs.  
± 219 x 20 x 9 mm



**77423**

USB flash drive with lanyard. Any Pantone® colour starting at 500 pcs.  
± 16 x 500 x 8 mm



**77641**

USB flash drive. Any Pantone® colour starting at 2.000 pcs.  
± 74 x 18 x 10 mm



**77700**

USB flash drive. PVC. Any special model available starting at 250 pcs.



## HOW TO ORDER YOUR CONNECTINGYOU LANYARD:

### 1 MODEL

Choose your model and colour. Available in any Pantone® colour.

### 2 CUSTOMISATION

Includes customisation with 2 colours.

### 3 EXTRAS

You can choose one or more of the 7 available extras for your lanyard. Includes the standard hook.

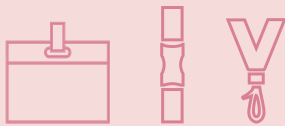

### 4 RESULT

A lanyard totally created by you!

## MODELS



**75440**

Lanyard.  
20 x 440 mm



Screen printing  
(solid colours)



Any Pantone®  
colour



**75441**

Lanyard.  
15 x 440 mm



Screen printing  
(solid colours)



Any Pantone®  
colour



DELIVERY TIME:  
from 17 business days,  
ref. 75444 from 19 business days



MOQ:  
1.000 pieces



**75442**

Lanyard.  
± 10 x 440 mm



Screen printing  
(solid colours)



Any Pantone®  
colour



**75443**

Lanyard.  
± 20 x 440 mm



Jacquard up to 5 colours  
(base colour + 4 colours)



Any Pantone®  
colour



**75444**

Lanyard.  
± Ø5 x 440 mm



Jacquard up to 5 colours  
(base colour + 4 colours)



Any Pantone®  
colour



**EXTRAS**



Basic hook



Oval hook



Plastic buckle



Safety lock



Mobile phone loop



ID holder



ID holder



5

## HOW TO ORDER YOUR CONNECTINGYOU BOTTLE:

### 1 CAPACITY

Choose your bottle depending on the capacity.

### 2 COLOURS

Any Pantone® solid or metallic colour.

### 3 CUSTOMISATION UP TO 360°

You can choose from laser, screen printing or transfer.

### 4 EXTRAS

Make your bottle unique with our extras.

### 5 RESULT

A bottle totally created by you!



**DELIVERY TIME:**  
from 71 business days



**MOQ:**  
2.500 pieces



MODEL



**74650**

Bottle. Aluminium. Capacity up to 400 ml.



**74651**

Bottle. Aluminium. Capacity up to 500 ml.



**74652**

Bottle. Aluminium. Capacity up to 750 ml.

EXTRAS



Screw top colours



Carabiner clip



CMYK

Gift box CMYK printed



# DOHABRANDS.

## LET'S MAKE IT REAL

# STOCK CATALOGUE 2022

SCAN IT



PROFILE



GIFT



STOCK

**Doha Brands Trading Co.**

Tel: +974 40284157

Fax: +974 40284199

Email: [info@doha-brands.com](mailto:info@doha-brands.com)

Web: [www.doha-brands.com](http://www.doha-brands.com)

